

TOSHIBA



Owner's Manual

Integrated High Definition DLP® Projection Television

COLOR STREAM® HD THEATER WIDE HD

DOLBY DIGITAL SRS WOW HDMI HDTV HIGH DEFINITION TELEVISION

57HM117 65HM117

For an overview of steps for setting up your new TV, see page 10.

Note: To display a High Definition picture, the TV must be receiving a High Definition signal (such as an over-the-air High Definition TV broadcast, a High Definition digital cable program, or a High Definition digital satellite program). For details, please contact your TV antenna installer, cable provider, or satellite provider.

Note: If the TV is powered off and then quickly on again when the lamp unit is hot, it may take several minutes for the picture to appear on-screen. This is a property of DLP® TV lamp technology and is NOT a sign of malfunction. For details, see "IMPORTANT NOTICE ABOUT HOT LAMP RESTART" on page 6.

Owner's Record

The model number and serial number are on the back of your TV. Record these numbers in the spaces below. Refer to these numbers whenever you communicate with your Toshiba dealer about this TV.

Model number:

Serial number:

Dear Customer,

Thank you for purchasing this Toshiba TV. This manual will help you use the many exciting features of your new TV. **Before operating the TV, please read this manual completely**, and keep it nearby for future reference.

Safety Precautions

WARNING: TO REDUCE THE RISK OF FIRE OR ELECTRIC SHOCK, DO NOT EXPOSE THIS APPLIANCE TO RAIN OR MOISTURE.



WARNING
RISK OF ELECTRIC SHOCK
DO NOT OPEN.



WARNING: TO REDUCE THE RISK OF ELECTRIC SHOCK, DO NOT REMOVE COVER (OR BACK). NO USER-SERVICEABLE PARTS INSIDE. REFER SERVICING TO QUALIFIED SERVICE PERSONNEL. (This does not apply to "Lamp unit replacement and care" in Chapter 9.)



The lightning flash with arrowhead symbol, within an equilateral triangle, is intended to alert the user to the presence of uninsulated "dangerous voltage" within the product's enclosure that may be of sufficient magnitude to constitute a risk of electric shock to persons.



The exclamation point within an equilateral triangle is intended to alert the user to the presence of important operating and maintenance (servicing) instructions in the literature accompanying the appliance.

Lamp Unit Replacement



CAUTION:
HOT SURFACE!



Touching the lamp before it has cooled will result in severe burns. ALLOW THE LAMP TO COOL FOR AT LEAST ONE (1) HOUR BEFORE REPLACING IT.

The lamp in this product has a limited service life. The length of service life varies depending on product use and user settings. If you use the lamp beyond its service life:

- you may notice a reduction in the colors and/or brightness of the picture, at which time you should replace the lamp unit; and
- the strength of the quartz glass in the lamp will be reduced and the lamp may rupture. If the lamp ruptures, the TV will not operate until the lamp unit is replaced.

Dispose of the used lamp unit by the approved method for your area.

See "Lamp unit replacement and care" in Chapter 9.



Note: The lamp unit contains mercury. Disposal of mercury may be regulated due to environmental considerations. For disposal or recycling information, contact your local authorities or the Electronic Industries Alliance (www.eiae.org).



CAUTION: This television is for use only with the supplied Toshiba stand (see page 66). Use with other carts or stands is capable of resulting in instability, causing possible injury.

NOTE TO CATV INSTALLERS IN THE U.S.A.

This is a reminder to call the CATV system installer's attention to Article 820-40 of the U.S. NEC, which provides guidelines for proper grounding and, in particular, specifies that the cable ground shall be connected to the grounding system of the building, as close to the point of cable entry as practical. For additional antenna grounding information, see items 28 and 29 on page 4.

Child Safety

It Makes A Difference Where Your TV Stands



Congratulations on your purchase!

As you enjoy your new TV, keep these safety tips in mind:

The Issue

- If you are like most consumers, you have a TV in your home. Many homes, in fact, have more than one TV.
- The home theater entertainment experience is a growing trend, and larger TVs are popular purchases; however, they are not always supported on the proper TV stands.
- Sometimes TVs are improperly secured or inappropriately situated on dressers, bookcases, shelves, desks, audio speakers, chests, or carts. As a result, TVs may fall over, causing unnecessary injury.

Toshiba Cares!



- The consumer electronics industry is committed to making home entertainment enjoyable and safe.
- The Consumer Electronics Association formed the Home Entertainment Support Safety Committee, comprised of TV and consumer electronics furniture manufacturers, to advocate children's safety and educate consumers and their families about television safety.

Tune Into Safety

- One size does NOT fit all! Use appropriate furniture large enough to support the weight of your TV (and other electronic components).
- Use appropriate angle braces, straps, and anchors to secure your furniture to the wall (but never screw anything directly into the TV).
- Carefully read and understand the other enclosed instructions for proper use of this product.
- Do not allow children to climb on or play with furniture and TVs.
- Avoid placing any item on top of your TV (such as a VCR, remote control, or toy) that a curious child may reach for.
- Remember that children can become excited while watching a program and can potentially push or pull a TV over.
- Share our safety message about this hidden hazard of the home with your family and friends. Thank you!



2500 Wilson Blvd.
Arlington, VA 22201 U.S.A.
www.CE.org

CEA is the Sponsor, Producer and
Manager of the International CES®

Important Safety Instructions

- 1) **Read these instructions.**
 - 2) **Keep these instructions.**
 - 3) **Heed all warnings.**
 - 4) **Follow all instructions.**
-
- 5) **Do not use this apparatus near water.**
-
- 6) **Clean only with dry cloth.**
-
- 7) **Do not block any ventilation openings.** Install in accordance with the manufacturer's instructions.
-
- 8) **Do not install near any heat sources** such as radiators, heat registers, stoves, or other apparatus (including amplifiers) that produce heat.
-
- 9) **Do not defeat the safety purpose of the polarized or grounding type plug.** A polarized plug has two blades with one wider than the other. A grounding type plug has two blades and a third grounding prong. The wide blade or the third prong are provided for your safety. If the provided plug does not fit into your outlet, consult an electrician for replacement of the obsolete outlet.

Wide blade

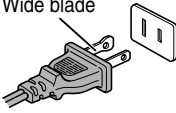
-
- 10) **Protect the power cord** from being walked on or pinched, particularly at plugs, convenience receptacles, and the point where they exit from the apparatus.

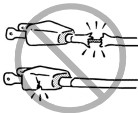
-
- 11) **Only use attachments/accessories specified by the manufacturer.**
-
- 12) **Use only with the cart, stand, tripod, bracket, or table specified by the manufacturer, or sold with the apparatus.** When a cart is used, use caution when moving the cart/apparatus combination to avoid injury from tip-over.

-
- 13) **Unplug this apparatus during lightning storms or when unused for long periods of time.**
-
- 14) **Refer all servicing to qualified service personnel.** Servicing is required when the apparatus has been damaged in any way, such as power-supply cord or plug is damaged, liquid has been spilled or objects have fallen into the apparatus, the apparatus has been exposed to rain or moisture, does not operate normally, or has been dropped.



- 15) **CAUTION:**
 - To reduce the risk of electric shock, do not use the polarized plug with an extension cord, receptacle, or other outlet unless the blades can be inserted completely to prevent blade exposure.
 - To prevent electric shock, match wide blade of plug to wide slot; fully insert.
-
- 16) **WARNING: This product contains a lamp to project the picture, and requires special safety precautions:**
 - See Chapter 9 for instructions on lamp unit replacement and care.
 - **DO NOT attempt to service this product except as specified in the "Lamp unit replacement and care" section in Chapter 9.** The only user-serviceable item in this product is the lamp unit.
-
- 17) **WARNING:** To prevent the spread of fire, keep candles or other open flames away from this product at all times.

Installation, Care, and Service

Installation

Follow these recommendations and precautions and heed all warnings when installing your TV:

- 18) Never modify this equipment. Changes or modifications may void: a) the warranty, and b) the user's authority to operate this equipment under the rules of the Federal Communications Commission.
-
- 19) **DANGER: RISK OF SERIOUS PERSONAL INJURY, DEATH, OR EQUIPMENT DAMAGE!**





Never place the TV on an unstable cart, stand, or table. The TV may fall, causing serious personal injury, death, or serious damage to the TV.
-
- 20) Never place or store the TV in direct sunlight; areas subject to excessive dust or vibration; or locations with temperatures at or below 41°F (5°C). See "Specifications" section on page 66 on operating conditions.
-
- 21) Always place the TV on the TV stand provided with the TV or on a sturdy, level, stable surface that can safely support the size and weight of the unit. See "Notice of possible TV stand instability" and "Child Safety" on page 2.
-
- 22) The apparatus shall not be exposed to dripping or splashing and that no objects filled with liquids, such as vases, shall be placed on the apparatus.
-
- 23) Always place the back of the television at least four (4) inches away from any vertical surface (such as a wall) to allow proper ventilation.

Additional Safety Precautions

- 14a) Item 14 does not apply to "Lamp unit replacement and care" in Chapter 9.
- 14b) **CAUTION:** If the TV is dropped and the cabinet or enclosure surface has been damaged or the TV does not operate normally, take the following precautions:
 - ALWAYS turn off the TV and unplug the power cord to avoid possible electric shock or fire.
 - To prevent personal injury, never handle the damaged television.
 - ALWAYS contact a service technician to inspect the TV any time it has been damaged or dropped.

(continued)

- 24) Never block or cover the slots or openings in the TV cabinet back, bottom, and sides. Never place the TV:
- on a bed, sofa, rug, or similar surface;
 - too close to drapes, curtains, or walls; or
 - in a confined space such as a bookcase, built-in cabinet, or any other place with poor ventilation.
- The slots and openings are provided to protect the TV from overheating and to help maintain reliable operation of the TV.
- 25) Never allow anything to rest on or roll over the power cord, and never place the TV where the power cord is subject to wear or abuse.
- 26) Never overload wall outlets and extension cords.
- 27) Always operate this equipment from a 120 VAC, 60 Hz power source only.
- 28) Always make sure the antenna system is properly grounded to provide adequate protection against voltage surges and built-up static charges (see Section 810 of the National Electric Code).

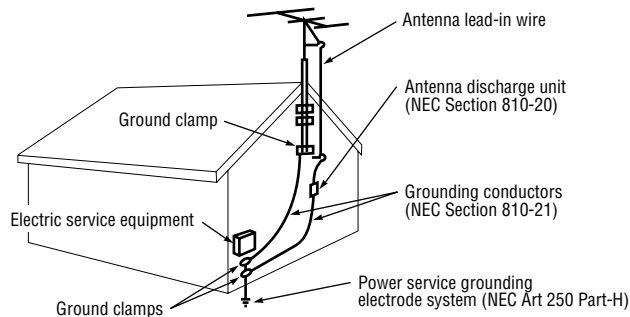



- 29)  **DANGER: RISK OF SERIOUS PERSONAL INJURY OR DEATH!**
- Use extreme care to make sure you are never in a position where your body (or any item you are in contact with, such as a ladder or screwdriver) can accidentally touch overhead power lines. Never locate the antenna near overhead power lines or other electrical circuits.
 - Never attempt to install any of the following during lightning activity: a) an antenna system; or b) cables, wires, or any home theater component connected to an antenna or phone system.

Care

For better performance and safer operation of your TOSHIBA TV, follow these recommendations and precautions:



- 30) Always sit approximately 10–25 feet away from the TV and as directly in front of it as possible. The picture can appear dull if you sit too far to the left or right of the TV, or if sunlight or room lights reflect on the screen. Turn the TV off to check for reflections on the screen, and then remove the source of reflections while viewing the TV.
- 31) Always unplug the TV before cleaning. Never use liquid or aerosol cleaners. Clean only with a soft, dry cloth. Do not spray volatile compounds, such as insecticide, on the cabinet. This may discolor or damage the cabinet.

- 32)  **WARNING: RISK OF ELECTRIC SHOCK!** 
Never spill liquids or push objects of any kind into the TV cabinet slots.

- 33) If the air temperature rises suddenly (for example, when the TV is first delivered), condensation may form on the lenses. This can make the picture appear distorted or the color appear faded. If this happens, turn off the TV for 6 to 7 hours to allow the condensation to evaporate.
- 34) For added protection of your TV from lightning and power surges, always unplug the power cord and disconnect the antenna from the TV if you leave the TV unattended or unused for long periods of time.
- 35) During normal use, the TV may make occasional snapping or popping sounds. This is normal, especially when the unit is being turned on or off. If these sounds become frequent or continuous, unplug the power cord and contact a Toshiba Authorized Service Center.

- 36) **Special care for DLP® (Digital Light Processing) units:**
- The lamp unit in this product has a limited service life. The length of service life varies depending on product use or user settings. If you use the lamp beyond its service life:
 - you may notice a reduction in the colors and/or brightness of the picture, at which time you should replace the lamp unit; and
 - the strength of the quartz glass in the lamp will be reduced and the lamp may rupture. If the lamp ruptures, the TV will not operate until the lamp unit is replaced. See “Lamp unit replacement and care” in Chapter 9.
 - Dispose of the used lamp unit by the approved method for your area.
 -  The lamp unit contains mercury. Disposal of mercury may be regulated due to environmental considerations. For disposal or recycling information, please contact your local authorities or the Electronic Industries Alliance (www.eiae.org).

Service

- 37)  **WARNING: RISK OF ELECTRIC SHOCK!** 
Never attempt to service the TV yourself, except as specified in the “Lamp unit replacement and care” section in Chapter 9. Opening and removing the covers may expose you to dangerous voltage or other hazards. Failure to follow this WARNING may result in death or serious injury. Refer all servicing not specified in this manual to a Toshiba Authorized Service Center.

- 38) If you have the TV serviced:
- Ask the service technician to use only replacement parts specified by the manufacturer.
 - Upon completion of service, ask the service technician to perform routine safety checks to determine that the TV is in safe operating condition.

DLP® and the DLP logo are registered trademarks of Texas Instruments.

- 39) When the TV reaches the end of its useful life, ask a qualified service technician to properly dispose of the TV.

Note: The lamp unit contains mercury. Disposal of mercury may be regulated due to environmental considerations. Dispose of the used lamp unit by the approved method for your area.

For disposal or recycling information, please contact your local authorities or the Electronic Industries Alliance (www.eiae.org).

FCC Declaration of Conformity Compliance Statement (Part 15):

The **Toshiba 57HM117 and 65HM117 Televisions** comply with Part 15 of the FCC rules.

Operation is subject to the following two conditions: (1) this device may not cause harmful interference, and (2) this device must accept any interference received, including interference that may cause undesired operation.

The party responsible for compliance to these rules is:
Toshiba America Consumer Products, L.L.C.
82 Totowa Rd. Wayne, NJ 07470.
Ph: 1-800-631-3811

Note: This equipment has been tested and found to comply with the limits for a Class B digital device, pursuant to Part 15 of the FCC rules. These limits are designed to provide reasonable protection against harmful interference in a residential installation. This equipment generates, uses, and can radiate radio frequency energy and, if not installed and used in accordance with the instructions, may cause harmful interference to radio communications. However, there is no guarantee that interference will not occur in a particular installation. If this equipment does cause harmful interference to radio or television reception, which can be determined by removing and applying power to the equipment, the user is encouraged to try to correct the interference by one or more of the following measures:

- Reorient or relocate the receiving antenna.
- Increase the separation between the equipment and the receiver.
- Connect the equipment into an outlet on a circuit different from that to which the receiver is connected.
- Consult the dealer or an experienced radio/TV technician for help.

Caution: Changes or modifications to this equipment not expressly approved by Toshiba could void the user's authority to operate this equipment.

Important notes about your DLP® projection TV

- 1) The light source for this TV is a projection lamp unit with a limited service life. When the lamp wears out, the picture may become dark or black or the lamp may fail, at which time you must replace the lamp unit (see “Lamp unit replacement and care” on pages 63–65).
- 2) When the lamp mode is set to **Low Power**, every time the TV is powered on, the lamp will initially be in **High Bright** mode but will switch to **Low Power** mode after a short period of time. You may notice a change in screen brightness when this happens. This is normal and is not a sign of malfunction (see page 57 for details).
- 3) Every time the TV is powered on, it may take several minutes for the picture to obtain full brightness (see “IMPORTANT NOTICE ABOUT HOT LAMP RESTART,” at right).
- 4) The TV’s display is manufactured using an extremely high level of precision technology; however, an occasional pixel (dot of light) may show constantly on the screen. This is a structural property of DLP® (Digital Light Processing®) technology and is not a sign of malfunction. Such pixels are not visible when the picture is viewed from a normal viewing distance.
- 5) Always sit approximately 10–25 feet away from the TV and as directly in front of it as possible. The picture quality may be affected by your viewing position and length of viewing time. If you sit too closely to the TV for too long, you may suffer from eye fatigue. See item 30 under “Care” on page 4.
- 6) Depending on the media you are viewing, it is possible, although unlikely, that a limited number of viewers may see a “rainbow effect” on the screen, which can, in rare instances, result in eye fatigue. This is a rare occurrence related to DLP® technology and is not a sign of TV malfunction.
- 7)  This TV contains several cooling fans to moderate the internal temperature. You may be able to hear the fans for several minutes after the TV is turned off. This is a function of the Power-On Mode feature and is not a sign of TV malfunction. You can set the Power-On Mode feature to stop the fans as soon as the TV is powered off. See “Setting the Power-On Mode feature” (see page 35).
- 8) The yellow and blue LED lights at the bottom center of the TV front indicate your TV’s current status. If either light flashes, see “LED indications” (see page 62).
- 9) Every time the TV power cord is plugged in, the yellow LED will blink until the TV enters standby mode (plugged in but not powered on). This is normal and is not a sign of malfunction.

“Voice announce” feature

When certain non-standard conditions occur, the LEDs on the TV will blink and the TV will play a recorded “voice announcement” describing the condition (see the LED indication table on page 62 for the specific conditions that include a voice announcement).

To repeat the voice announcement and hear additional information, press the MENU button on the TV while the LEDs are blinking.

IMPORTANT NOTICE ABOUT HOT LAMP RESTART

When the TV has been powered on long enough for the lamp unit to get hot, it may take several minutes for the picture to appear in the following situations:

- When the Power-On Mode feature is set to **Power-Saving** and you turn the TV off and then on again within a few minutes; or
- If the TV is on when a short-term power failure, power surge, or other similar power failure occurs, such that the TV loses and regains power within a few minutes.

This is a property of DLP® TV lamp technology and is NOT a sign of malfunction.

If this occurs, the yellow LED on the TV front panel will blink (and the blue LED will be lit solid) until the TV is finished restarting the lamp and the normal picture appears. If both LEDs are blinking, you will need to turn the TV off and then on again to restart the lamp.

Trademark Information

- WOW, SRS and  symbol are trademarks of SRS Labs, Inc. WOW technology is incorporated under license from SRS Labs, Inc.
- Manufactured under license from Dolby Laboratories. Dolby and the double-D symbol are registered trademarks of Dolby Laboratories.
- HDMI, the HDMI logo and High-Definition Multimedia Interface are trademarks or registered trademarks of HDMI Licensing LLC.
- DLP® and the DLP logo are registered trademarks of Texas Instruments.

Contents

Chapter 1: Introduction	9	Scrolling the TheaterWide® picture (TheaterWide 2 and 3 only)	42
Welcome to Toshiba	9	Using the auto aspect ratio feature	43
Features of your new TV	9	Selecting the cinema mode (480i and 1080i signals)	43
Overview of steps for installing, setting up, and using your new TV	10	Adjusting the picture	44
TV front and side panel controls and connections	11	Selecting the picture mode	44
TV back panel connections	12	Adjusting the picture quality	44
Chapter 2: Connecting your TV	13	Using the closed caption mode	45
Overview of cable types	13	Base closed captions	45
About the connection illustrations	13	Digital CC Settings	45
Connecting a VCR and antenna or Cable TV (no Cable box)	14	CC Selector	46
Connecting a VCR with S-video and a cable box	15	Adjusting the audio	46
Connecting a DVD player with ColorStream® (component video), a VCR, and a satellite receiver	16	Muting the sound	46
Connecting a device to the IR OUT infrared terminal using the IR blaster cable for IR pass-through device control	17	Using the digital audio selector	46
Connecting a camcorder	18	Selecting stereo/SAP broadcasts	47
Connecting an HDMI™ or DVI device to the HDMI input	19	Adjusting the audio quality	47
Connecting a digital audio system	20	Using the StableSound® feature	48
Connecting an audio system	20	Selecting the optical audio output format	48
Connecting a personal computer (PC)	21	Using the Dolby® Digital Dynamic Range Control feature	48
Chapter 3: Using the remote control	22	Using the Locks menu	49
Preparing the remote control for use	22	Entering the PIN code	49
Installing the remote control batteries	22	If you cannot remember your PIN code	49
Remote control effective range	22	Changing your PIN code	49
Learning about the remote control	23	Blocking TV programs and movies by rating (V-Chip)	50
Using the remote control to control your other devices	24	Downloading an additional rating system for blocking TV programs and movies	50
Remote Control functional key chart	25	Blocking channels	51
Programming the remote control to control your other devices	26	Unlocking programs temporarily	52
Remote control codes	27	Using the input lock feature	52
Chapter 4: Menu layout and navigation	29	Using the control panel lock feature	53
Main menu layout	29	Using the PC settings feature	53
Setup/Installation menu layout	30	Setting the PC Audio	54
Navigating the menu system	30	Setting the sleep timer	54
Chapter 5: Setting up your TV	31	Displaying TV status information	55
Selecting the menu language	31	Understanding the auto power off feature	55
Configuring the antenna input source for the ANT terminal	31	Understanding the last mode memory feature	55
Programming channels into the TV's channel memory	32	Chapter 7: Using the TV's advanced features	56
Programming channels automatically	32	Using the advanced picture settings features	56
Manually adding and deleting channels in the channel memory	32	Using dynamic contrast	56
Labeling channels	33	Using the static gamma feature	56
Setting the HDMI™ audio mode	34	Selecting the color temperature	57
Setting the Power-On Mode feature	35	Selecting the lamp mode	57
Viewing the digital signal meter	35	Using CableClear® digital noise reduction	58
Viewing the system status	36	Using MPEG noise reduction	58
Chapter 6: Using the TV's features	37	Using the Game Mode feature	59
Selecting the video input source to view	37	Using the advanced audio settings features	59
Labeling the video input sources	37	Using the SRS WOW™ surround sound feature	59
Tuning channels	38	Chapter 8: Troubleshooting	60
Tuning channels using the Channel Browser™	38	General troubleshooting	60
Tuning to the next programmed channel	40	LED indications	62
Tuning to a specific channel (programmed or unprogrammed)	40		
Switching between two channels using Channel Return	40		
Switching between two channels using SurfLock™	40		
Selecting the picture size	41		

(continued)

Chapter 9: Appendix	63
Lamp unit replacement and care	63
Replacing the lamp unit (User-replaceable component)	63
When to replace the lamp unit	63
How to replace the lamp unit	64
Disposing of the used lamp unit	65
Specifications	66
Limited United States Warranty for DLP® Television Models	67
Limited Canadian Warranty for Toshiba Brand DLP® Television Models	68
Index	71

Chapter 1: Introduction



**NOTICE OF POSSIBLE TV STAND INSTABILITY
DANGER: RISK OF SERIOUS PERSONAL
INJURY OR DEATH!** Use this TV only with
the supplied TOSHIBA TV stand. Use with other
stands may result in instability, causing possible injury or
death.

Welcome to Toshiba

Thank you for purchasing this Toshiba TV, one of the most innovative DLP® projection TVs on the market. This digital television is capable of receiving analog basic, digital basic and digital premium cable television programming by direct connection to a cable system providing such programming. A security card provided by your cable operator is required to view encrypted digital programming. Certain advanced and interactive digital cable services such as video-on-demand, a cable operator's enhanced program guide and data-enhanced television services may require the use of a set-top box. For more information call your local cable operator.

Features of your new TV

The following are just a few of the many exciting features of your new Toshiba widescreen, integrated HD, DLP® projection TV:

- 1080p output resolution
- **Integrated digital tuning (8VSB ATSC and QAM)** eliminates the need for a separate digital converter set-top box (in most cases).
- **Three HDMI™** digital, high-definition multimedia interfaces 1080p input support (☞ page 19).
- **Two sets of ColorStream® HD** high-resolution component video inputs (☞ page 16).
- **SRS WOW™** audio technologies (☞ page 59).
- **Digital Audio Out** optical audio connection with Dolby® Digital optical output format (☞ page 48).
- **CableClear®** digital picture noise reduction (☞ page 58).
- **PC IN (Analog RGB)** computer terminal (☞ page 21).
- **IR OUT** infrared terminal using the IR blaster cable for IR pass-through device control (☞ page 13).
- **Channel Labeling** allows you to put the Call Letters (e.g. ABC, HBO, etc.) on the screen along with the station numbers, so you always know what you're watching (☞ page 33).

Chapter 1: Introduction

Overview of steps for installing, setting up, and using your new TV

Follow these steps to set up your TV and begin using its many exciting features.

- 1** Carefully read the important safety, installation, care, and service information. Keep this manual for future reference.
- 2** Observe the following when choosing a location for the TV:
 - Read “Important notes about your DLP® projection TV” (☞ page 6).
 - Place the TV on the applicable optional TV stand listed in the “Specifications” section (if available for this TV model) or on a sturdy, level, stable surface that can safely support the size and weight of the unit.
 - Place the TV in a location where light does not reflect on the screen.
 - Place the TV far enough from walls and other objects to allow proper ventilation. Inadequate ventilation may cause overheating, which will damage the TV. **THIS TYPE OF DAMAGE IS NOT COVERED UNDER THE TOSHIBA WARRANTY.**
- 3** Do not plug in any power cords until AFTER you have connected all cables and devices to your TV.
- 4** BEFORE connecting cables or devices to the TV, learn the functions of the TV’s connections and controls (☞ pages 11–12).
- 5** Connect your other electronic device(s) to the TV (☞ pages 13–21).
- 6** Install the batteries in the remote control (☞ page 22).
- 7** See “Learning about the remote control” (☞ page 23) for an overview of the buttons on the remote control.
- 8** Program the remote control to operate your other device(s) (☞ pages 24–28).
- 9** AFTER connecting all cables and devices, plug in the power cords for your TV and other devices.
- 10** After you plug in the TV power cord, the yellow LED (on the TV front) will blink 3 times. Wait several seconds until the yellow LED stops blinking and then press **POWER** on the TV or remote control.
See “LED indications” (☞ page 62).
- 11** See “Menu layout and navigation” for a quick overview of navigating the TV’s menu system (☞ page 29).
- 12** Program channels into the TV’s channel memory (☞ page 32).
- 13** For details on using the TV’s features, see Chapters 6 and 7.
- 14** For help, refer to the Troubleshooting Guide, Chapter 8.
- 15** For lamp unit replacement instructions, see Chapter 9.
- 16** For technical specifications and warranty information, see Chapter 9.
- 17** Enjoy your new TV!

Chapter 1: Introduction

TV front and side panel controls and connections

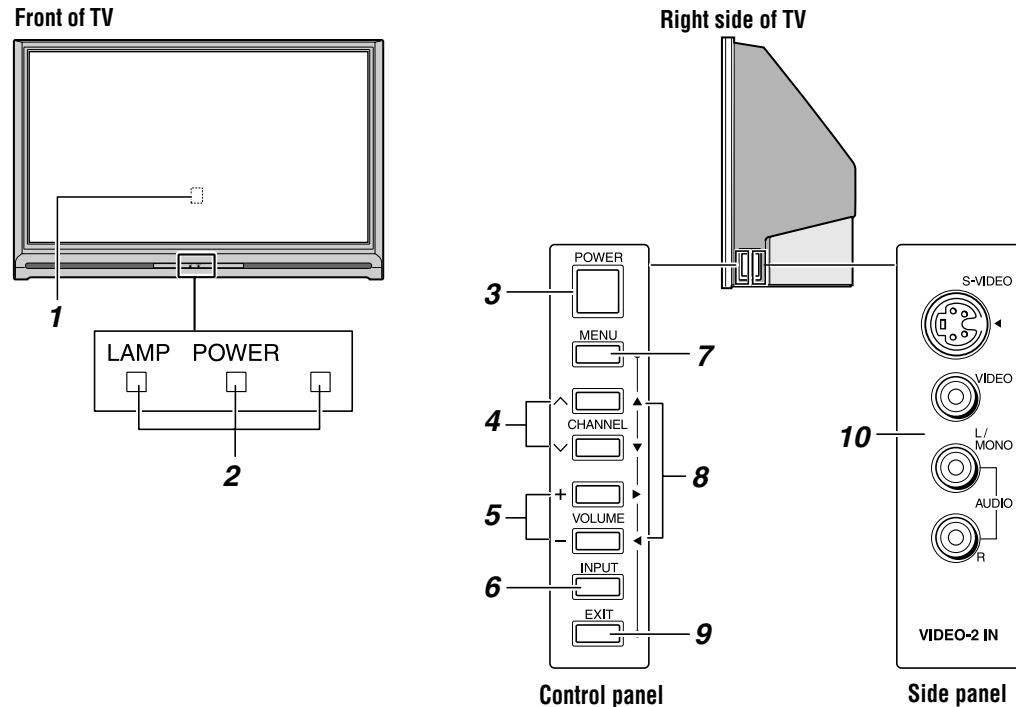

- 1 Remote sensor** (behind the screen) — Point the remote control toward this area of the TV screen (see “Remote control effective range” on page 22).
- 2 Blue, Yellow, and Green/Red**
See “LED indications” on page 62 for additional information.
- 3 POWER** — Press to turn the TV on and off.
If the TV stops responding to the controls on the remote control or TV control panel and you cannot turn off the TV, press and hold the **POWER** button on the TV control panel for 5 or more seconds to reset the TV.
- 4 CHANNEL** $\wedge \vee$ — When no menu is on-screen, these buttons change the channel (programmed channels only; see page 32).
- 5 VOLUME** $+ -$ — These buttons adjust the volume level.
- 6 INPUT** — Repeatedly press to change the source you are viewing (**ANT**, **VIDEO 1**, **VIDEO 2**, **ColorStream HD1**, **ColorStream HD2**, **HDMI 1**, **HDMI 2**, **HDMI 3**, **PC**).
- 7 MENU (ENTER)** — Press to access the menu system (see pages 29–30). When a menu is on-screen, the **MENU** button on the TV’s control panel functions as the **ENTER** button.
- 8 ARROWS** $\blacktriangle \blacktriangledown \blacktriangleleft \blacktriangleright$ — When a menu is on-screen, these buttons function as up/down/left/right menu navigation buttons.

9 EXIT — Press to instantly close an on-screen menu.

10 VIDEO-2 IN — The side panel A/V connections are referred to as “**VIDEO 2**” and include standard A/V inputs plus an optional S-video input.

Note: Standard (composite) video and S-video cables carry only video information; separate audio cables are required for a complete connection.

Chapter 1: Introduction

TV back panel connections

For an explanation of cable types and connections, see pages 13–21.

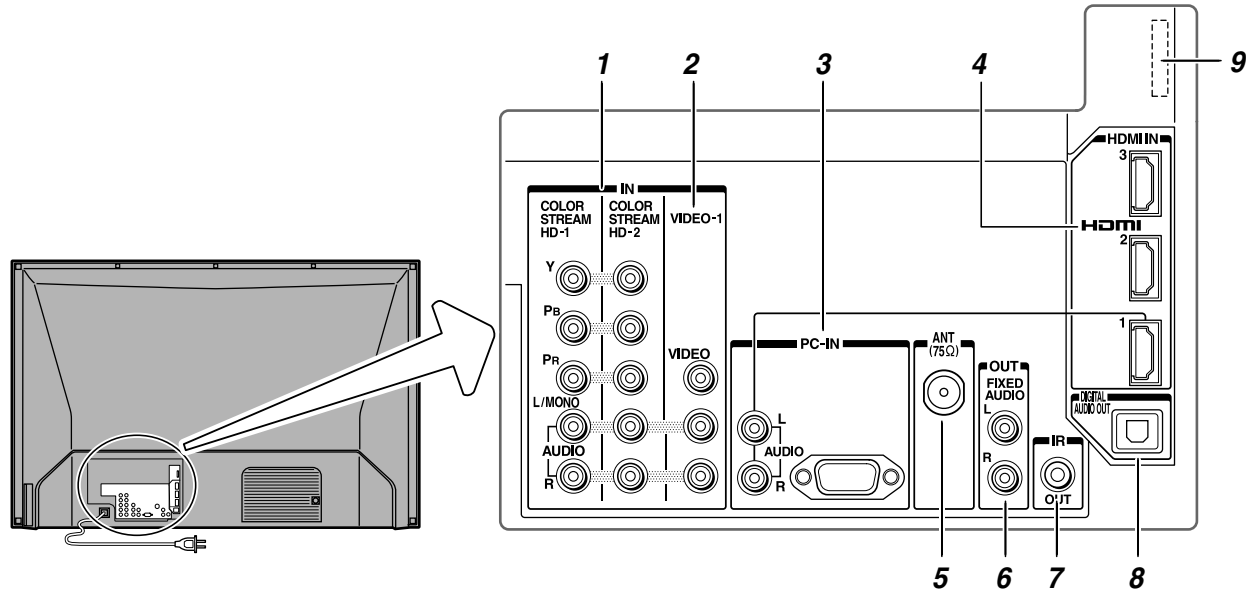

- 1 ColorStream® HD-1 and ColorStream® HD-2** — Two sets of ColorStream® high-definition component video inputs (with standard stereo audio inputs) for connecting devices with component video output, such as a Toshiba DVD player with ColorStream®.

Note: Component video cables carry only video information; separate audio cables are required for a complete connection.

- 2 VIDEO-1 IN** — Standard (composite) video and standard audio inputs for connecting devices with composite video output.
- 3 PC IN** — For use when connecting a personal computer. PC audio input terminals are shared with HDMI-1 analog audio input terminals, and their use can be configured in the **Audio Setup** menu (see page 54).
- 4 HDMI™ IN** — High-Definition Multimedia Interface input receives digital audio and uncompressed digital video from an HDMI device or uncompressed digital video from a DVI device. Also see item 3. HDMI connection is necessary to receive 1080p signals.
- 5 ANT** — Antenna input that supports analog (NTSC) and digital (ATSC) off-air antenna signals and analog and digital Cable TV (QAM) signals.
- 6 Fixed Audio OUT** — Analog audio outputs for connecting an audio amplifier.

- 7 IR OUT** — For controlling infrared remote-controlled devices through the TV. You can connect up to two devices with an IR blaster cable, and then control the devices using the TV's IR pass-through features.

- 8 Digital Audio OUT** — Optical audio output in Dolby Digital or PCM (pulse-code modulation) format for connecting an external Dolby Digital decoder, amplifier, A/V receiver, or home theater system with optical audio input.

- 9 Service port (behind the cover)** — For service use only. Used for updating the television's firmware.

HDMI, the HDMI logo and High-Definition Multimedia Interface are trademarks or registered trademarks of HDMI Licensing LLC. Manufactured under license from Dolby Laboratories. Dolby and the double-D symbol are registered trademarks of Dolby Laboratories.

Chapter 2: Connecting your TV

Overview of cable types

Coaxial (F-type) cable



Coaxial (F-type) cable is used for connecting your antenna, cable TV service, and/or cable converter box to the **ANT** input on your TV.

Standard A/V cables (red/white/yellow)

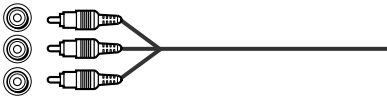

Standard A/V cables (composite video) usually come in sets of three, and are for use with video devices with analog audio and composite video output. These cables (and the related inputs on your TV) are typically color-coded according to use: yellow for video, red for stereo right audio, and white for stereo left (or mono) audio.

S-video cable



S-video cable is for use with video devices with S-video output. Separate audio cables are required for a complete connection.

Note: An S-video cable provides better picture performance than a composite video cable. If you connect an S-video cable, be sure to disconnect the standard (composite) video cable or the picture performance will be unacceptable.

Component video cables (red/green/blue)

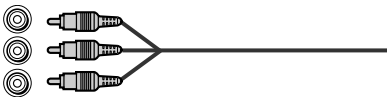

Component video cables come in sets of three and are for use with video devices with component video output.

(ColorStream® is Toshiba's brand of component video.) These cables are typically color-coded red, green, and blue. Separate audio cables are required for a complete connection.

Note: Component video cables provide better picture performance than a standard (composite) video or S-video cable.

HDMI™ cable

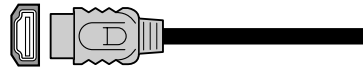

HDMI (High-Definition Multimedia Interface) cable is for use with devices with an HDMI output. An HDMI cable delivers digital audio and video in its native format. This cable carries both video and audio information; therefore, separate audio cables are not required for a complete HDMI device connection (see page 19 and page 21).

Note: HDMI cable provides better picture performance than a standard (composite) video or S-video cable.

Dual-wand IR blaster cable



Dual-wand IR blaster cable is for use with video devices with IR (infrared) remote control. This cable can be used with the TV's IR pass-through feature (see page 17).

To obtain IR blaster cable:
Visit www.ceaccessories.toshiba.com.

Optical audio cable



Optical audio cable is for connecting receivers with Dolby Digital or PCM (pulse-code modulation) optical audio input to the TV's **DIGITAL AUDIO OUT** terminal (see page 20).

Analog RGB (15-pin) computer cable

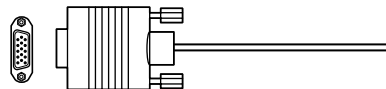

Analog RGB (15-pin) computer cable is for connecting a PC to the TV's **PC IN** terminal (see page 21).

About the connection illustrations

You can connect different types and brands of devices to your TV in several different configurations. The connection illustrations in this manual are representative of typical device connections only. The input/output terminals on your devices may differ from those illustrated herein. For details on connecting and using your specific devices, refer to each device's owner's manual.

Chapter 2: Connecting your TV

Connecting a VCR and antenna or Cable TV (no Cable box)

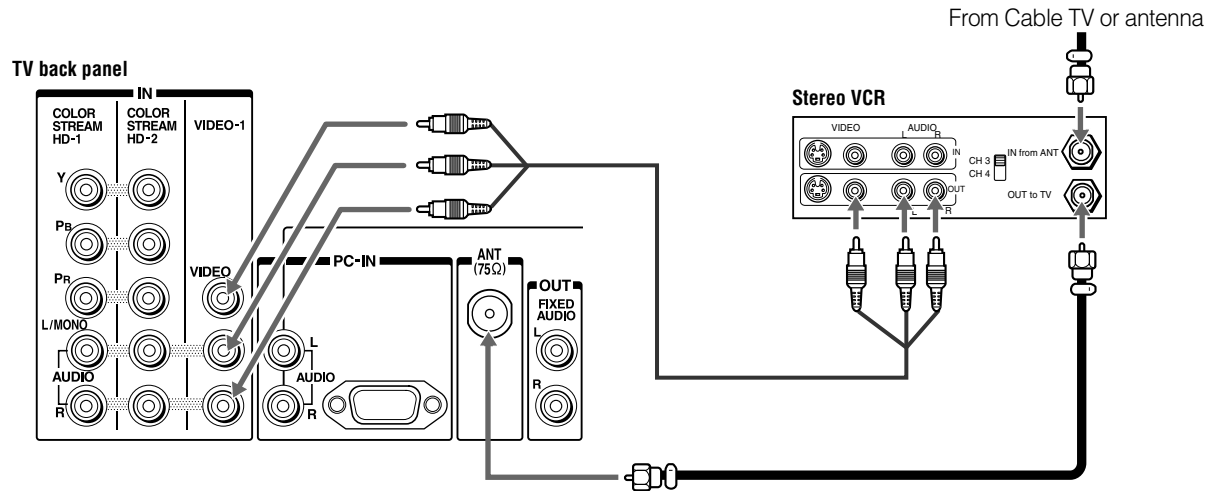

You will need:

- coaxial cables
- standard A/V cables
 - For better picture performance, if your VCR has S-video, use an S-video cable (plus the audio cables) to **VIDEO 2** on the side panel (instead of to **VIDEO 1**). Do not connect both types of video cable to **VIDEO 2** at the same time or the picture performance will be unacceptable.
 - If you have a mono VCR, connect **L/MONO** on the TV to your VCR's audio out terminal using the white audio cable only.

To view the antenna or Cable signal:

Select the **ANT** video input source on the TV.*

To view the VCR:

Turn ON the VCR. Select the **VIDEO 1** video input source on the TV.*

* To select the video input source, press **INPUT** on the remote control (see page 23). To program the TV remote control to operate other devices, see Chapter 3.

The unauthorized recording, use, distribution, or revision of television programs, videotapes, DVDs, and other materials is prohibited under the Copyright Laws of the United States and other countries, and may subject you to civil and criminal liability.

Chapter 2: Connecting your TV

Connecting a VCR with S-video and a cable box

An S-video connection will provide better picture performance than a standard (composite) video cable.

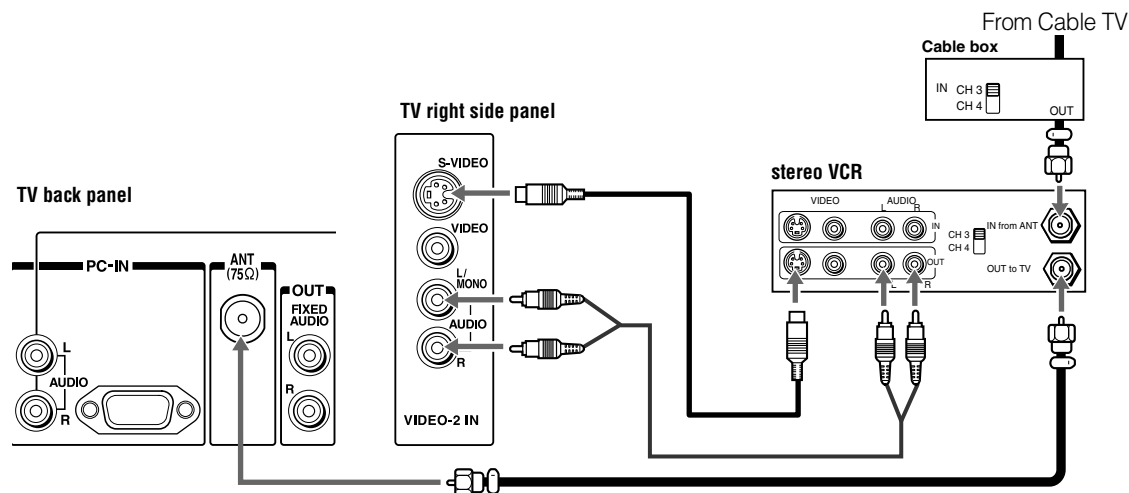

You will need:

- coaxial cables
- S-video cable
 - Do not connect both types of video cable to **VIDEO 2** at the same time or the picture performance will be unacceptable.
- standard audio cables
 - If you have a mono VCR, connect **L/MONO** on the TV to your VCR's audio out terminal using the white audio cable only.

Note: When you use a Cable box, you may not be able to use the remote control to program or access certain features on the TV.

To view basic and premium Cable channels:

Turn OFF the VCR. Select the **ANT** video input source on the TV.* Tune the TV to channel 3 or 4 (whichever channel the Cable box output is set to). Use the Cable box controls to change channels.

To view the VCR:

Turn ON the VCR. Select the **VIDEO 2** video input source on the TV.*

* To select the video input source, press **INPUT** on the remote control (see page 23). To program the TV remote control to operate other devices, see Chapter 3.

The unauthorized recording, use, distribution, or revision of television programs, videotapes, DVDs, and other materials is prohibited under the Copyright Laws of the United States and other countries, and may subject you to civil and criminal liability.

Chapter 2: Connecting your TV

Connecting a DVD player with ColorStream® (component video), a VCR, and a satellite receiver

Your TV has two sets of ColorStream® (component video) inputs.

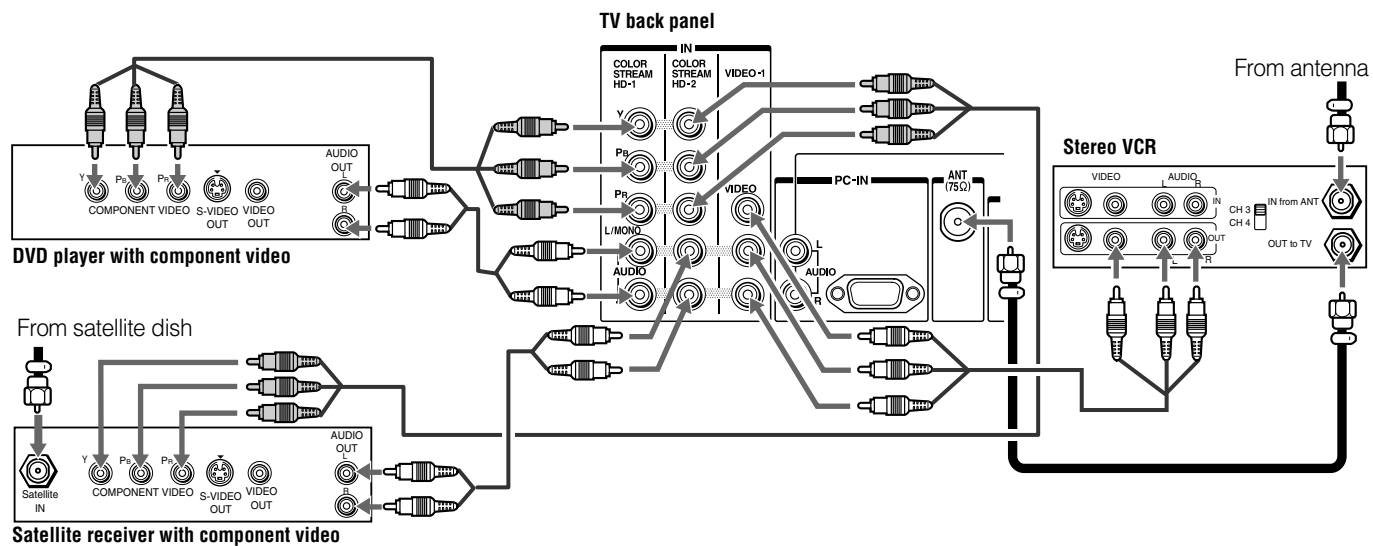

You will need:

- coaxial cables
- standard A/V cables
 - For better picture performance, if your VCR has S-video, use an S-video cable (plus the audio cables) to **VIDEO 2** on the side panel (instead of to **VIDEO 1**). Do not connect both types of video cable to **VIDEO 2** at the same time or the picture performance will be unacceptable.
 - If you have a mono VCR, connect **L/MONO** on the TV to your VCR's audio out terminal using the white audio cable only.
- standard audio cables
- component video cables
 - You can connect the component video cables (plus audio cables) from the DVD player or satellite receiver to either set of **ColorStream** terminals on the TV (**HD-1** or **HD-2**). The **ColorStream HD-1** and **HD-2** terminals can be used with Progressive (480p, 720p) and Interlaced (480i, 1080i) scan systems. A 1080i signal will provide the best picture performance (1080p is not supported).
 - If your DVD player or satellite receiver does not have component video, connect a standard A/V cable to **VIDEO 2** on the side panel. If your DVD player has HDMI video, see page 19.

To view antenna or Cable channels:

Select the **ANT** video input source on the TV.*

To view the DVD player:

Turn ON the DVD player. Select the **ColorStream HD-1** video input source on the TV.*

To view satellite programs using the component video connections:

Turn on the satellite receiver. Select the **ColorStream HD-2** video input source on the TV.*

To view the VCR or view and record antenna channels:

Turn ON the VCR. Tune the VCR to the channel you want to watch. Select the **VIDEO 1** video input source on the TV.*

To record a TV program while watching a DVD:

Turn ON the VCR. Tune the VCR to the channel to record. Select the **ColorStream HD-1** video input source on the TV* to view the DVD.

* To select the video input source, press **INPUT** on the remote control (page 23). To program the TV remote control to operate other devices, see Chapter 3.

The unauthorized recording, use, distribution, or revision of television programs, videotapes, DVDs, and other materials is prohibited under the Copyright Laws of the United States and other countries, and may subject you to civil and criminal liability.

Chapter 2: Connecting your TV

Connecting a device to the IR OUT infrared terminal using the IR blaster cable for IR pass-through device control

You can use the TV's **IR OUT** terminal (infrared pass-through) to remotely operate (through the TV) many infrared remote-controlled devices (such as Toshiba infrared remote-controlled VCRs or DVD players) enclosed within an entertainment center or similar cabinet. Without the **IR OUT** connection, the device typically would need to be visible to operate it remotely.

You will need:

- dual-wand IR blaster cable (see page 13)
- other audio/video cables as required to connect the device(s) to the TV (see pages 14–19)

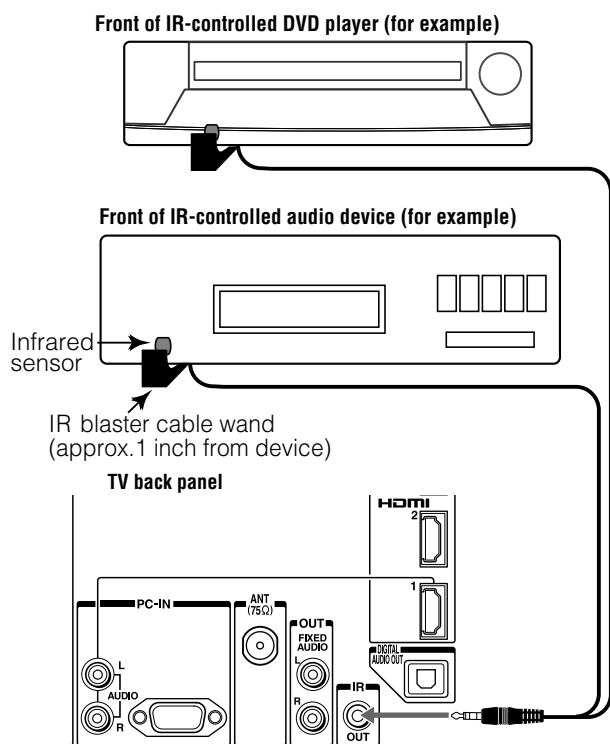

To connect the IR blaster cable:

- 1 Locate the infrared sensor on the front of your device. This sensor is marked on some devices.*
- 2 Align one of the IR blaster cable's wands about 1 inch away from the infrared sensor on the front of the device and attach it using double-sided mounting tape. If you have a second device, attach the second wand in a similar manner. (See illustration.)

Note: If you do not have a second device, coil the second wand with a rubber band and leave it behind the TV.

- 3 Plug the IR blaster cable's plug into the TV's **IR OUT** terminal.

To control the device(s):

Point either the device's remote control or the TV remote control (that you previously programmed to operate the device; see Chapter 3) toward the front of the TV and press the button for the desired function. The signal passes from the remote control through the TV to the device via the IR blaster cable.

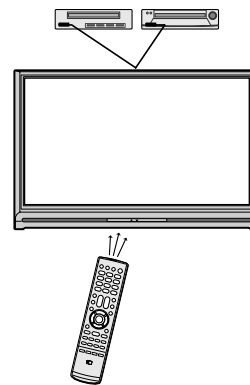

Note:

- If you use the device's remote control to operate the device, you also will need to use the TV's remote control to operate the TV.
- The IR pass-through feature does not support all IR-controlled devices; satisfactory performance may not be attainable with certain devices.

*If you cannot locate the device's infrared sensor:

- 1 Turn OFF the device.
- 2 Starting at the lower left corner of the device, place the end of the device's remote control (with the infrared emitter) so it touches the front of the device and press **POWER**. (Do not use the TV's remote control for this step.)
- 3 If the device turns on, the point at which the remote control touched the device is the location of the sensor.
- 4 If the device does not turn on, move the remote control slightly to the right and press **POWER** again.
- 5 Repeat step 4 until you locate the device's infrared sensor.

Chapter 2: Connecting your TV

Connecting a camcorder

You will need:

- standard A/V cables
 - For better picture performance, if your camcorder has S-video, connect an S-video cable (plus the audio cables).

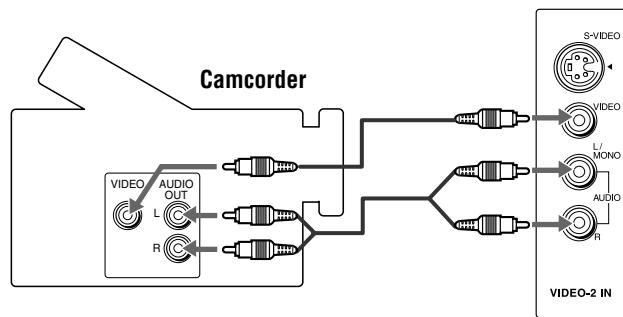

VIDEO 2 inputs on TV right side panel

To view the camcorder video:

Select the **VIDEO 2** video input source on the TV.*

* To select the video input source, press **INPUT** on the remote control (page 23). To program the TV remote control to operate other devices, see Chapter 3.

Chapter 2: Connecting your TV

Connecting an HDMI™ or DVI device to the HDMI input

The HDMI input on your TV receives digital audio and uncompressed digital video from an HDMI source device, or uncompressed digital video from a DVI (Digital Visual Interface) source device.

This input is designed to accept HDCP (High-Bandwidth Digital-Content Protection) program material in digital form from EIA/CEA-861-861B-compliant^[1] consumer electronic devices (such as a set-top box or DVD player with HDMI or DVI output).

The HDMI input is designed for best performance with 1080p signals but will also accept and display 480i, 480p, 720p, and 1080i signals.

Note: To connect a PC to the HDMI input, see page 21.

To connect an HDMI device, you will need:

- one HDMI cable (type A connector) per HDMI device
 - For proper operation, it is recommended that you use an HDMI cable with the HDMI Logo (HDMI™). You should use an HDMI cable shorter than 16.4 ft (5m) for 1080p input signals.
 - HDMI cable transfers both video and audio. Separate analog audio cables are not required (see illustration).
 - See “Setting the HDMI™ audio mode” (page 34).

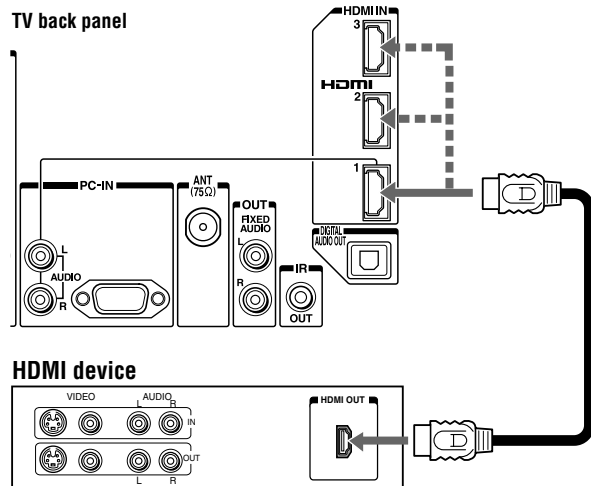

To view the HDMI device video:

Select the HDMI 1, HDMI 2, or HDMI 3 video input source on the TV.*

Note: If the audio output mode of the HDMI device is other than the L-PCM mode, the TV speakers will not output sound.

* To select the video input source, press **INPUT** on the remote control (page 23). To program the TV remote control to operate other devices, see Chapter 3.

To connect a DVI device, you will need:

- one HDMI-to-DVI adapter cable (HDMI type A connector) per DVI device
 - For proper operation, the length of an HDMI-to-DVI adapter cable should not exceed 9.8 ft (3m). The recommended length is 6.6 ft (2m).
- one pair of standard analog audio cables per DVI device
 - An HDMI-to-DVI adapter cable transfers video only. Separate analog audio cables are required (see illustration).
 - See “Setting the HDMI™ audio mode” (page 34).

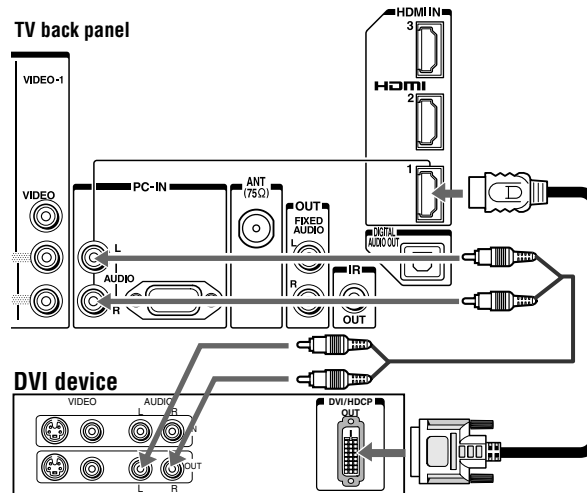

Note: To ensure that the HDMI or DVI device is reset properly, it is recommended that you follow these procedures:

- When turning on your electronic components, **turn on the TV first**, and then the HDMI or DVI device.
- When turning off your electronic components, **turn off the HDMI or DVI device first**, and then the TV.

[1] EIA/CEA-861-861B compliance covers the transmission of uncompressed digital video with high-bandwidth digital content protection, which is being standardized for reception of high-definition video signals. Because this is an evolving technology, it is possible that some devices may not operate properly with the TV.

HDMI, the HDMI logo and High-Definition Multimedia Interface are trademarks or registered trademarks of HDMI Licensing LLC.

Chapter 2: Connecting your TV

Connecting a digital audio system

The TV's **DIGITAL AUDIO OUT** terminal outputs a Dolby®* Digital  or 2-channel down-mixed PCM (pulse-code modulation) signal for use with an external Dolby® Digital decoder or other external audio system with optical audio input.

You will need:

- optical audio cable (Use an optical audio cable that has the larger "TosLink" connector and not the smaller "mini-optical" connector.)

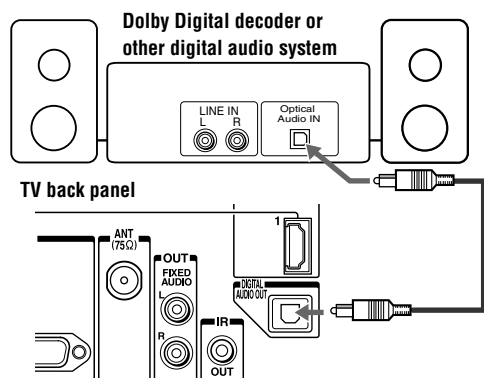

To control the audio:

- Turn on the TV and the digital audio device.
- Press **MENU** on the TV's remote control and open the **Audio** menu.
- Highlight **Audio Setup** and press **ENTER**.

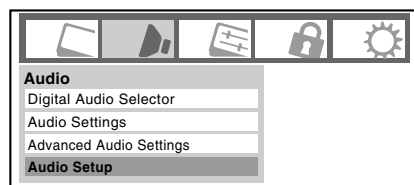

- In the **Optical Output Format** field, select either **Dolby Digital** or **PCM**, depending on your device (for "Selecting the optical audio output format" on page 48).

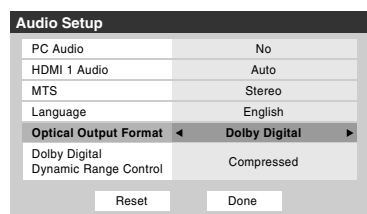

Note:

- Some audio systems may not be compatible with Dolby Digital bitstream signals. Older audio systems that are not compatible with standard optical out signals may not work properly, creating a high noise level that may damage speakers or headphones. **THIS DAMAGE IS NOT COVERED BY YOUR WARRANTY.**
- The **DIGITAL AUDIO OUT** terminal may not output some digital audio sources because of copy restrictions.

* Manufactured under license from Dolby Laboratories. Dolby, and the double-D symbol are registered trademarks of Dolby Laboratories.

Connecting an audio system

This connection allows you to use external speakers with an external analog audio amplifier to adjust the sound level.

You will need:

- standard audio cables

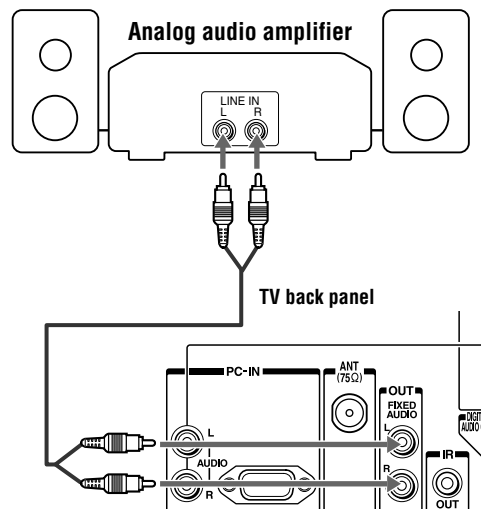

To control the audio:

- Turn on the TV and the stereo amplifier.
- Minimize the sound volume from the TV's built-in speakers and control the volume level using the amplifier's remote control.

Chapter 2: Connecting your TV

Connecting a personal computer (PC)

To connect a PC to the PC IN terminal on the TV:

When connecting a PC to the PC IN terminal on the TV, use an analog RGB (15-pin) computer cable and a PC audio cable.

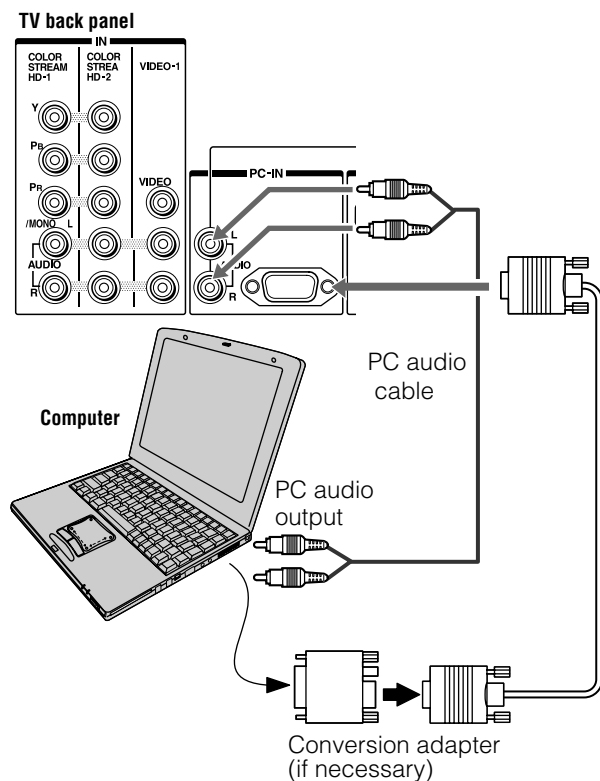

- To use a PC, set the monitor output resolution on the PC before connecting it to the TV. The following signals can be displayed:

Format	Resolution	V. Frequency
VGA	640 × 480	60Hz
SVGA	800 × 600	60Hz
XGA	1024 × 768	60Hz

Other formats or non-standard signals will not be displayed correctly.

- To display the optimum picture, use the PC setting feature (see "Using the PC settings feature" on page 53).

Note:

- The PC audio input terminals on the TV are shared with the HDMI-1 analog audio input terminals (see page 54).
- Some PC models cannot be connected to this TV.
- An adapter is not needed for computers with a compatible mini D-sub 15-pin terminal.

- Depending on the DVD's title and the specifications of the PC on which you are playing the DVD-Video, some scenes may be skipped or you may not be able to pause during multi-angle scenes.

To connect a PC to the HDMI terminal on the TV:

When connecting a PC to the HDMI terminal on the TV, use an HDMI-to DVI adapter cable and analog audio cables.

If connecting a PC with an HDMI terminal, use an HDMI cable (type A connector). Separate analog cables are not necessary (see page 19).

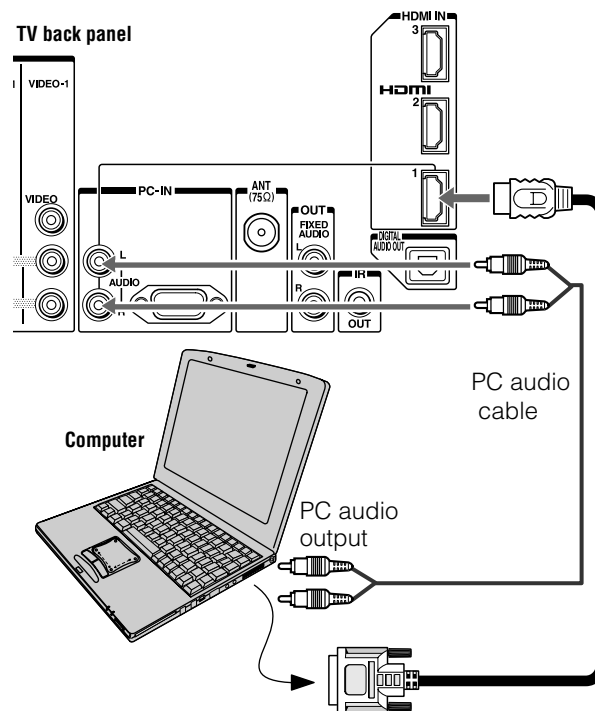

- The following signal formats can be displayed:

Format	Resolution	V. Frequency
VGA	640 × 480	59.94/60Hz
480i (60Hz)	720 × 480	59.94/60Hz
480p (60Hz)	720 × 480	59.94/60Hz
720p (60Hz)	1280 × 720	59.94/60Hz
1080i (60Hz)	1920 × 1080	59.94/60Hz
1080p (24/60Hz)	1920 × 1080	59.94/60Hz

Note: The edges of the images may be hidden.

Chapter 3: Using the remote control

Preparing the remote control for use

Your TV remote control can operate your TV and many other devices such as cable converter boxes, satellite receivers, VCRs, DVD players, and HTIBs (home theater in a box), even if they are different brands.

If you have a Toshiba device:

Your TV remote control is preprogrammed to operate most Toshiba devices (see page 26).

If you have a non-Toshiba device or a Toshiba device that the remote control is not preprogrammed to operate:

You can program the TV remote control so it will operate the other device (see pages 24–28).

Installing the remote control batteries

- 1 Remove the battery cover from the back of the remote control.

Squeeze tab and lift cover.

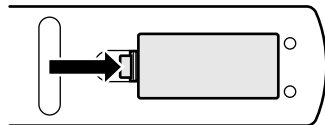

- 2 Install two “AAA” size batteries, making sure to match the + and – signs on the batteries to the signs on the battery compartment.

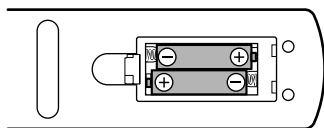

- 3 Reinsert the battery cover in the remote control until the tab snaps.

Caution: Never throw batteries into a fire.

Note:

- Be sure to use AAA size batteries.
- Dispose of batteries in a designated disposal area.
- Batteries should always be disposed of with the environment in mind. Always dispose of batteries in accordance with applicable laws and regulations.
- If the remote control does not operate correctly, or if the operating range becomes reduced, replace batteries with new ones.
- When necessary to replace batteries in the remote control, always replace both batteries with new ones. Never mix battery types or use new and used batteries in combination.

- Always remove batteries from the remote control if they are dead or if the remote control is not to be used for an extended period of time. This will prevent battery acid from leaking into the battery compartment.

Remote control effective range

For optimum performance, aim the remote control directly at the TV and make sure there is no obstruction between the remote control and the TV.

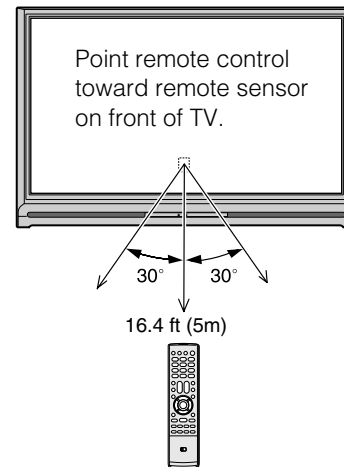

Chapter 3: Using the remote control

Learning about the remote control

The buttons used for operating the TV only are described here. For a complete list of the remote control's functions, see the remote control functional key chart (page 25).

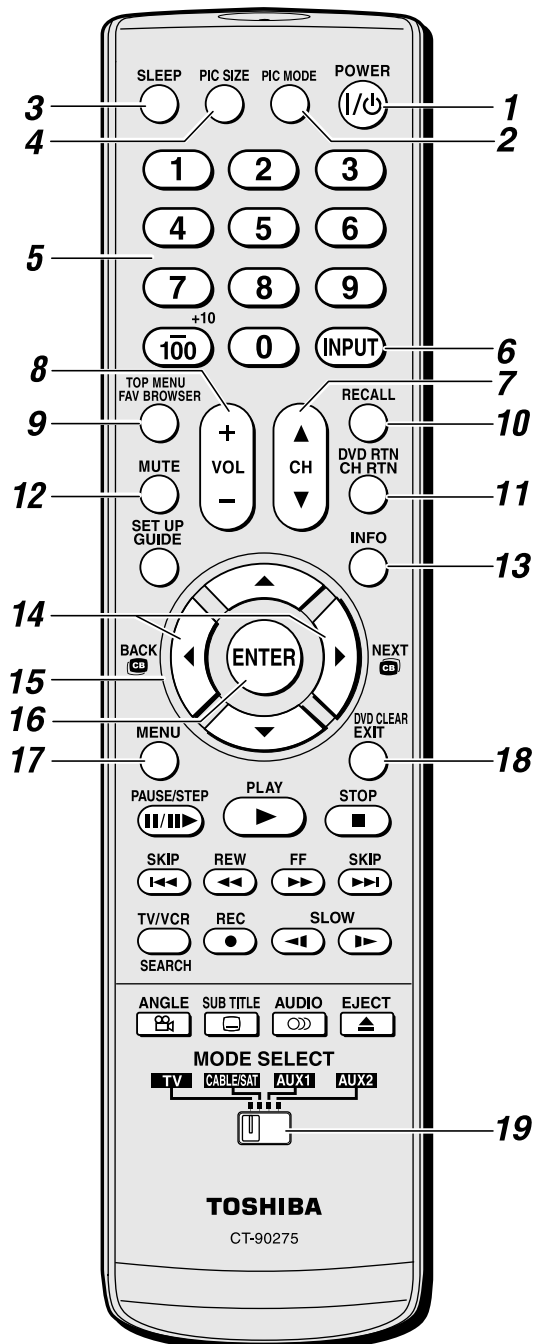

Note: The error message "Not Available" may appear if you press a key for a function that is not available.

1 POWER turns the TV on and off. Press **POWER** to turn on the TV, The blue LED indicator on the TV front will be illuminated. Press **POWER** again to turn off the TV.

Note: The Power-On Mode setting will affect the amount of time it takes for the picture to appear when you turn on the TV (page 35).

- 2 PIC MODE** selects the picture mode (page 44).
- 3 SLEEP** accesses the sleep timer (page 54).
- 4 PIC SIZE** cycles through the picture sizes: **Natural**, **TheaterWide 1/2/3**, **Full**, and **4:3 HD** (page 41).
- 5 Channel Numbers (0-9, -/100)** directly tune channels. The **100** button is used to tune digital channels (page 40) or to edit the Favorites List (page 38).
- 6 INPUT** selects the video input source (page 37).
- 7 CH ▲▼** cycles through programmed channels when no menu is on-screen (page 32).
- 8 VOL + -** adjusts the volume level.
- 9 FAV BROWSER** accesses the Favorites List in the Channel Brower™ (page 38).
- 10 RECALL** displays TV status information (page 55).
- 11 CH RTN** returns to the last viewed channel or source (page 40).
- 12 MUTE** reduces or turns off the sound (page 46).
- 13 INFO** displays TV status information as well as program details, when available (page 55).
- 14 BACK ◀ / NEXT ▶** While watching TV, these buttons open the Channel Brower™ and tune to the previous/next channel in the channel history (page 39). (Also see "Arrow buttons.")
- 15 Arrow buttons (▲▼◀▶)** When a menu is on-screen, these buttons select or adjust programming menus. (Also see BACK ◀ / NEXT ▶.)
- 16 ENTER** activates highlighted items in the main menu system.
- 17 MENU** accesses the main TV menu system (pages 29 and 30).
- 18 EXIT** closes on-screen menus.
- 19 MODE SELECT switch** switches between TV, CABLE/SAT, AUX 1, and AUX 2 modes (page 24). Set to "TV" to control the TV.

Chapter 3: Using the remote control

Using the remote control to control your other devices

If you have a non-Toshiba device or a Toshiba device that the remote control is not preprogrammed to operate, you must first program the remote control to recognize the device (if you have not already done so) (see pages 26–28).

To use your TV remote control to operate a:

- Cable converter box or satellite receiver, set the **MODE SELECT** switch to **CABLE/SAT**.
- VCR, set the **MODE SELECT** switch to **AUX 1**.
- DVD player or HTIB, set the **MODE SELECT** switch to **AUX 2**.

Note: Even after the TV remote control is programmed, it may not operate certain features on any other devices. If this happens and you wish to use those features, you will need to use the device's original remote control.

Point the remote control directly at the device.

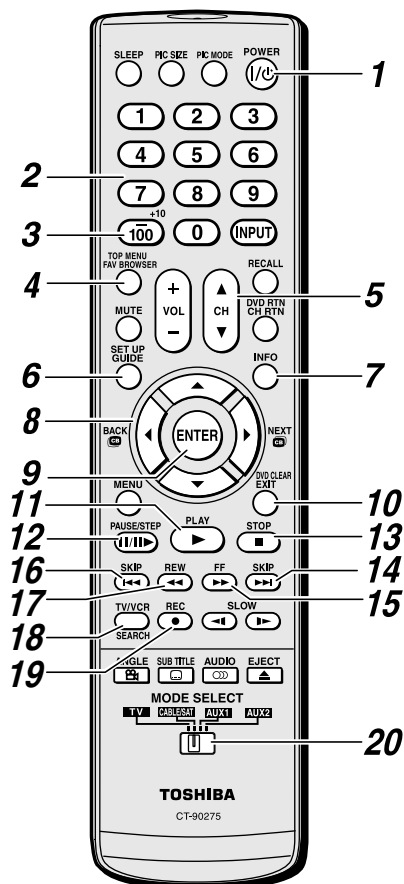

- 1 POWER** Turns the selected device on and off.
- 2 Channel Numbers (0-9)** Press to directly access channels (as opposed to CH ▲ ▼).
- 3 +10** Press to directly access DVD chapters higher than 10.
- 4 TOP MENU** Accesses a DVD's top menu.
- 5 CH ▲ ▼** For channels programmed into the channel memory (see page 40):
 - ▲ selects the next higher channel.
 - ▼ selects the next lower channel.
- 6 GUIDE** Displays the channel guide in the CABLE/SAT mode.
SET UP Accesses a DVD's setup menu in the AUX mode.
- 7 INFO** Displays TV status information on-screen.
- 8 ▲ ▼ ◀ ▶** Press to navigate DVD menus (may not work on some DVD players).
- 9 ENTER** Required by some satellite receivers and DVD players to activate certain functions.
- 10 DVD CLEAR** Press to reset the title and chapter number.
- 11 PLAY** Begins playback of a tape or DVD.
- 12 PAUSE** Press during play or record mode to pause the picture; press again to restart.
- 13 STOP** Stops the tape or DVD.
- 14 SKIP ▶▶** Skips forward to locate later DVD chapters.
- 15 FF** Fast-forwards the tape or DVD. (Press during play mode to view the picture moving rapidly forward.)
- 16 SKIP ◀◀** Skips back to beginning of current DVD chapter, or locates previous chapters.
- 17 REW** Rewinds/reverses the tape or DVD. (Press during play mode to view the picture moving rapidly backward.)
- 18 TV/VCR** To view one program while recording another, press to select TV mode.
SEARCH selects a specific DVD chapter, title or time.
- 19 REC** Starts tape recording.
- 20 MODE SELECT switch** Set to "TV" to control the TV; "CABLE/SAT" to control a cable converter box or satellite receiver; "AUX 1" to control a VCR; "AUX 2" to control a DVD player or HTIB.

Chapter 3: Using the remote control

Remote Control functional key chart

Note:

- "---" = key does not send a signal in that remote control mode.
- "← TV" = key will affect the TV, even though the remote control is in another mode.
- * Not available for your TV.

REMOTE CONTROL KEY	Toshiba TV	CABLE	SAT (satellite)	AUX 1 (VCR)	AUX 2 (DVD or HTIB)
POWER	Power	Power	Power	Power	Power
SLEEP	Sleep timer	← TV	← TV	← TV	← TV
PIC SIZE	Picture size	← TV	← TV	← TV	← TV
PIC MODE	PIC MODE	← TV	← TV	← TV	← TV
1-9	Digit 1-9	Digit 1-9	Digit 1-9	Digit 1-9	Digit 1-9
0	Digit 0	Digit 0	Digit 0	Digit 0	Digit 0
100/-/+10	- (sub CH)	---	- (sub CH)	100	+10
INPUT	TV/Video select	← TV	← TV	← TV	← TV
FAV BROWSER/ TOP MENU	FAV BROWSER DVD TOP Menu*	---	---	---	Top Menu
MUTE	Sound mute	← TV	← TV	← TV	← TV
SET UP/GUIDE	Guide*	---	SAT Guide	---	Setup
VOL + -	Volume up/down	← TV	← TV	← TV	← TV
CH▲▼	Channel up/down	Channel up/down	Channel up/down	Channel up/down	---
RECALL	RECALL	← TV	← TV	← TV	← TV
CH RTN/DVD RTN	Previous channel DVD previous menu*	---	---	---	DVD Return
INFO	Info	---	Info	---	Display
ENTER	Enter	---	Select, Enter	---	Enter
▲▼	Menu up/down	---	Menu up/down	---	Menu up/down
BACK CB	Menu left/ Channel Browser™	---	Menu left	---	Menu left
NEXT CB	Menu right/ Channel Browser™	---	Menu right	---	Menu right
MENU	Menu	---	Action Menu	---	DVD Menu
EXIT/DVD CLEAR	Exit DVD clear*	---	Exit	---	DVD Clear
PAUSE/STEP	Pause*	---	---	Pause	Pause
PLAY	Play*	---	---	Play	Play
STOP	Stop*	---	---	Stop	Stop
SKIP ◀◀	Skip REV*	---	---	---	Skip REV
SKIP ▶▶	Skip FWD*	---	---	---	Skip FWD
REW	Rewind*	---	---	Rewind	Rewind
FF	Fast FWD*	---	---	Fast FWD	Fast FWD
TV/VCR/ SEARCH	DVD search*	---	---	TV/VCR	DVD search
REC	REC MENU*	---	---	Record (2 click)	---
SLOW -	SLOW REW*	---	---	---	---
SLOW +	SLOW FWD*	---	---	---	---
ANGLE	Angle*	---	---	---	DVD Angle
SUB TITLE	Sub title*	---	---	---	DVD Sub title
AUDIO	Audio*	---	---	---	DVD Audio
EJECT	Eject*	---	---	---	DVD Eject

Chapter 3: Using the remote control

Programming the remote control to control your other devices

Your Toshiba TV remote control is preprogrammed to operate most Toshiba devices. To program your TV remote control to operate a non-Toshiba device (or a Toshiba device that it is not preprogrammed to operate), follow the steps below. For details on using the remote control to operate the device, see page 24.

- 1 In the remote control code table (page 27), find the code for your device. If more than one code is listed, try each one separately until you find one that works.
- 2 Set the **MODE SELECT switch** to the type of device you are programming the remote control to operate — CABLE/SAT (for a cable converter box or satellite receiver), AUX 1 (for a VCR or TV/VCR combo), or AUX 2 (for a DVD player or HTIB [home theater in a box]).
- 3 While holding down **RECALL**, press the Channel Number buttons to enter the 3-digit code for your device.
- 4 To test the code, turn on the device, point the remote control at it, and press **POWER**. See notes below.
 - If the correct code was entered, the device will turn off.
 - If the device does not respond, repeat steps 1–4 using another code.
 - If the device does not respond to another code, you will need to use the remote control that came with the device.
- 5 Remember to set the **MODE SELECT switch** back to “TV” to control the TV.
- 6 For future reference, write down the code(s) you used:

DEVICE	CODE	DEVICE	CODE

Note:

- In addition to **POWER**, confirm that all necessary keys on the TV remote control operate your device. If some keys are not operational, repeat the device code setup using another code (if other codes are listed for your device). If, after trying all listed codes, the necessary keys do not operate your device, use the device's original remote control.
- Every time you change the batteries, you will need to reprogram the remote control.
- Some newer VCRs respond to either of two codes. These VCRs have a switch labeled “VCR1/VCR2.” If your VCR has this kind of switch and does not respond to the codes for your VCR brand, set the switch to the other position (“VCR1” or “VCR2”) and reprogram the remote control.

Chapter 3: Using the remote control

Remote control codes

In some cases you may not be able to operate your device with the TV remote control. Your other device may use a code that is not recognized by the TV remote control. If this happens, use the device's remote control.

Cable converter box

ABC	061, 062, 063, 082, 084, 087, 092, 096, 098
Archer	065, 092, 097, 099
Cableview	064, 094
Century	092
Citizen	090, 092, 097
Contec	083, 085, 086, 088, 093, 098
Diamond	093
GE	061, 062
Gemini	069, 070, 094
Hamlin	093
Hitachi	062, 095, 096
Jasco	097
Motorola/GI/Jerrold	062, 069, 071, 082, 086, 089, 096, 107
Magnavox	072, 096
Memorex	092, 104
Multi Canal	090
Novavision	101
Panasonic	081, 083, 085
Philco	087
Philips	066, 067, 068, 070, 072, 073, 074, 075, 092
Pioneer	076, 077
Proscan	061, 062
Radio Shack	092, 097, 099
RCA	064, 081
Realistic	065
Recoton	102
Samsung	077, 090
Scientific Atlanta	063, 078, 079, 080, 088, 098, 101, 105
Sears	095
Signature	062
Signature 2000	096
Sprucer	081, 085
Starcom	069, 082, 087, 096, 103, 104
Stargate	069, 090
Sylvania	095, 100
TeleView	090
Texscan	100
Tocom	071, 084, 085
U. S. Electronics	087, 096, 098
United Cable	082
Universal	065, 092, 097, 099, 102, 103
Wards	096

Satellite receiver

Alphastar	038, 059
Chaparral	034
DISH Network	057

Drake	020, 040, 044, 046, 050, 053
Echostar	018, 041, 051
Express Vu	057
Fujitsu	027
GE	008, 009, 013
General Instruments	010, 011, 012, 022, 023, 031, 049
Hitachi	033
Hughes	033
Hughes Network Systems	019
Intersat	048
Janeil	027
JVC	017, 057
Kenwood	029
Magnavox	060
Optimus	058
Pansat	036, 052
Primestar	015, 042
Proscan	008, 009, 013
Radio Shack	022, 023, 030
RCA	008, 009, 013, 016
Realistic	030
Samsung	059
Sony	014, 055
Star Choice	057, 106
Star Trak	025, 026, 037, 054
STS	024
Toshiba	000, 001, 002, 003, 004, 005, 006, 007, 020, 031, 056
Uniden	021, 028, 030, 032, 035, 039, 043, 045, 047, 058
Zenith	027

TV/VCR Combo

Action	078
GE	059, 062
Goldstar	065
Panasonic	065
Precision	078
Quasar	065
Realistic	079
Sony	074
Toshiba	057
Zenith	065
Totevision	009, 010, 065

DVD/VCR Combo

Go Video	DVD=087, VCR=081
JVC	DVD=088, VCR=082
RCA	DVD=089, VCR=083
Samsung	DVD=090, VCR=084
Sanyo	DVD=091, VCR=085
Zenith	DVD=092, VCR=086

DVD player

Aiwa	006, 015
Apex	016, 017
BOSE	097
Broksonic	018

Clarion	019
Classic	020
Daewoo	021
Denon	022, 023, 024, 025
Emerson	026, 027
Fisher	028
Funai	027
GE	001, 029, 030
Go Video	087
GPX	031
Hitachi	005, 032, 033, 034, 035
JVC	003, 007, 036, 042, 088
Kenwood	037
Konka	008, 009
Magnavox	004, 038
Memorex	039
Mintek	040
NAD	026
Nakamichi	041
Norcent	043
Onkyo	044
Oritron	058
Panasonic	010, 045, 046, 047, 048, 049, 050
Philips	004, 051
Pioneer	052, 053, 054, 055
Proscan	001, 056
Qwestar	057, 058
RCA	001, 002, 059, 089
Sampo	060
Samsung	061, 062, 086, 090
Sansui	073
Sanyo	063, 091
Sharp	064, 067
Sherwood	074
Sony	011, 012, 065, 066, 068, 069, 070
Sylvania	027
Teac	071
Technics	072
Techwood	075
Toshiba	000, 013, 076, 077, 078
Yamaha	079, 080, 081
Zenith	014, 082, 092

Portable DVD player

Aiwa	093
Audiovox	094, 095
Panasonic	024, 096, 099
RCA	098

VCR

Admiral	049
Aiko	019
Aiwa	018
Akai	003, 004, 037, 038, 039, 058, 069
Audiovox	010
Bell & Howell	007, 068
Broksonic	008, 017
Calix	010
Carver	026
CCE	019
Citizen	009, 010, 011, 012, 013, 014, 015, 019, 057, 073
Colortyme	005

Chapter 3: Using the remote control





Craig	009, 010, 016, 061, 065, 079	Orion	054, 057, 062, 065, 068, 072	Video Concepts	005, 006, 011, 012, 039, 053
Curtis Mathes	001, 005, 009, 012, 014, 040, 048, 053, 056, 057	Panasonic	036, 045, 046, 057, 061, 072, 079	Wards	009, 010, 011, 016, 018, 020, 024, 025, 031, 035, 049, 051, 056, 057, 060, 065, 066, 079
Daewoo	011, 013, 015, 017, 018, 019, 057, 078	Pentax	012, 024, 025, 035, 042, 053, 063	White Westinghouse	073
Daytron	078	Pentex Research	014	XR-1000	018
Denon	063	Philco	026, 027, 063	Yamaha	005, 006, 007, 014, 037, 053
Dimensia	001, 048	Philips	026, 031, 044, 057	Zenith	004, 032, 034, 041, 047, 069, 086
Electrohome	010, 020, 065	Pioneer	006, 024, 043, 055	HTIB	
Emerson	003, 008, 010, 011, 017, 018, 020, 028, 039, 054, 057, 062, 065, 068, 072	Portland	012, 013, 015	Lasonic	083
Fisher	007, 016, 021, 022, 023, 057, 064, 068, 070, 071, 079	Proscan	001, 002, 048	Panasonic	084
Fuji	004, 041	Proton	061	Venturer	085
Funai	018, 073	Quasar	045		
Garrard	018	Radio Shack	010, 031, 065		
GE	001, 002, 009, 040, 042, 048, 056	Radio Shack/Realistic	007, 009, 010, 016, 018, 020, 021, 022, 031, 049		
Go Video	056, 059, 061, 081	Radix	010		
Goldstar	005, 010, 014, 054, 056, 065, 067	RCA	001, 002, 003, 009, 024, 025, 029, 035, 040, 042, 045, 048, 055, 056, 063, 071, 083		
Gradiente	018, 065	Realistic	007, 009, 010, 011, 016, 018, 020, 021, 022, 031, 049, 051, 056, 060, 065, 075, 079		
Harman Kardon	005	Ricoh	047		
Hitachi	024, 025, 035, 037, 042, 063, 070, 080	Runco	034		
JBL	076	Samsung	009, 011, 038, 056, 073, 084		
JC Penney	005, 006, 007, 008, 009, 010, 023, 024, 025, 026, 035, 056, 061, 063, 065	Sansui	006, 037, 043, 061		
Jensen	024, 025, 037, 050	Sanyo	007, 009, 016, 054, 064, 068, 071, 075, 079, 085		
JVC	005, 006, 007, 014, 037, 043, 055, 062, 063, 068, 082	Scott	008, 011, 017, 028, 030, 057, 065, 072		
Kenwood	005, 006, 007, 012, 014, 037, 043, 050, 053, 068, 071	Sears	007, 010, 016, 021, 022, 023, 024, 025, 035, 053, 057, 063, 064, 065, 068, 071, 075, 079		
Kodak	010	Sharp	013, 020, 031, 049, 051, 060, 066		
LG	010	Shintom	004, 025, 032, 061		
Lloyds	053, 073, 079	Signature	049		
Logik	061	Signature 2000	075		
LXI	010	Singer	047, 061		
Magnasonic	061, 065, 078	Sony	004, 032, 033, 041, 052, 058, 070, 074, 076, 077, 080		
Magnavox	026, 027, 034, 044, 057, 061, 072	STS	035		
Marantz	005, 006, 007, 012, 014, 026, 053, 067	Sylvania	018, 026, 027, 028, 044, 072		
Memorex	007, 009, 010, 016, 018, 034, 049, 063, 065, 066, 068, 075, 079	Symphonic	018, 050, 051, 053, 073, 079		
MGA	020, 028, 039	Tandy	007		
MGN	056	Tashiko	010		
Minolta	024, 025, 035, 063	Tatung	037		
Mitsubishi	020, 024, 025, 028, 039, 043, 065	Teac	018, 029, 037		
Montgomery Ward	049	Technics	036		
Motorola	049	Teknika	010, 018, 065		
MTC	009, 046, 061	Toshiba	000, 011, 021, 023, 024, 028, 030, 039, 057, 074, 078, 079		
Multitech	009, 012, 018	Totevision	009, 010, 065		
NEC	005, 006, 007, 012, 014, 037, 043, 053, 054, 067, 070	Unitec	073		
Nikko	010	Unitech	009		
Noblex	009	Vector Research	005, 006, 011, 012, 053		
Optimus	010, 049, 065				
Optonica	031				

Chapter 4: Menu layout and navigation

Main menu layout

The tables below and on the next page provide a quick overview of your TV's menu system.



To open the main menus (illustrated below), press  on the remote control or TV control panel.



Icon	Item	Option	Page
	Mode	→ Sports/Standard/Movie/Preference	44
	Picture Settings	→ [Opens the Picture Settings menu]	44
	Noise Reduction	→ [Opens the Noise Reduction menu]	58
	Game Mode	→ On/Off	59
	Theater Settings	→ [Opens the Theater Settings menu]	41
	Digital Audio Selector	→ [Launches the temporary Audio Selector]	46
	Audio Settings	→ [Opens the Audio Settings menu]	47
	Advanced Audio Settings	→ [Opens the Advanced Audio Settings menu]	59
	Audio Setup	→ [Opens the Audio Setup menu]	47
	CC Selector	→ [Launches the temporary CC Selector]	46
	Base CC Mode	→ OFF/CC1/CC2/CC3/CC4/T1/T2/T3/T4	45
	Digital CC Settings	→ [Opens the Digital CC Setup menu]	45
	Input Labeling	→ [Opens the Input Labeling menu]	37
	Channel Labeling	→ [Opens the Channel Labeling menu]	33
	Menu Language	→ English/French/Spanish	31
	Channel Browser Setup	→ [Opens the Channel Browser Setup menu]	38
	Enable Rating Blocking	→ Off/On	50
	Edit Rating Limits	→ [Opens the Edit Rating Limits menu]	50
	Channels Block	→ [Opens the Channels block menu]	51
	Input Lock	→ Off/Video/Video+	52
	Front Panel Lock	→ Off/On	53
	New PIN Code	→ [Opens the New PIN Code entry screen]	49
	Installation	→ [Opens the Installation menu]	31
	Sleep Timer	→ [Opens the Sleep Timer menu]	54
	PC Settings	→ [Opens the PC Settings menu]	53
	Power-On Mode	→ Power-Saving/Fast	35

Chapter 4: Menu layout and navigation

Setup/Installation menu layout







The Installation menu contains the Terrestrial and System Status menus.

To open the **Installation** menu (illustrated below), press  on the remote control or TV control panel, open the **Setup** menu, select **Installation**, and press .

	Icon	Item	Option	Page
Press  , open the Setup menu, and then open the Installation sub-menu.		Input Configuration	→ [Opens the Input Configuration menu]	31
		Channel Program	→ [Start] → [Scans for new channels on ANT]	32
		Channel Add/Delete	→ [Opens the Channel Add/Delete menu]	32
		Signal Meter	→ [Opens the Signal Meter menu]	35
		System Information	→ [Opens the System Information screen]	36

Navigating the menu system

You can use the buttons on the remote control or TV control panel to access and navigate your TV's on-screen menu system.

- Press  to open the menu system.
- When a menu is open, use the up/down/left/right arrow buttons (, , , ) on the remote control or TV control panel to move in the corresponding direction in the menu.
- Press  to save your menu settings or select a highlighted item. (A highlighted menu item appears in a different color in the menu.)
- All menus close automatically if you do not make a selection within 60 seconds, except the signal meter menu, which closes automatically after about 5 minutes.
- To close a menu instantly, press .

Note:

- The menu background may sometimes appear black, depending on the signal the TV is receiving. This is not a sign of malfunction.

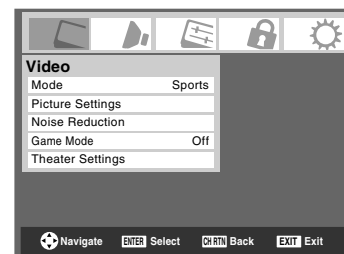

- The Video sub-menu appears with a black background, which looks different from other menus.

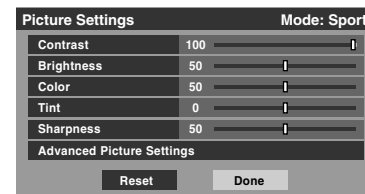

Chapter 5: Setting up your TV

Selecting the menu language

You can choose from three different languages (English, French and Spanish) for the on-screen display of menus and messages.

To select the menu language:

- 1 Press **MENU** and open the **Preferences** menu.
- 2 Highlight **Menu Language** and press **▶**.
- 3 Press **▲** or **▼** to select your preferred menu language and press **ENTER**.

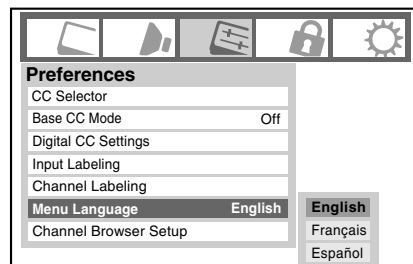

- 4 Press **EXIT** to close the **Preferences** menu.

Configuring the antenna input source for the ANT terminal

To configure the ANT input source:

- 1 Press **MENU** and open the **Setup** menu.
- 2 Highlight **Installation** and press **ENTER**.

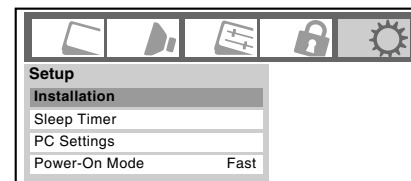

- 3 (A new set of **Installation** menu icons will appear, as shown below.) Open the **Terrestrial** menu, highlight **Input Configuration**, and press **ENTER**.

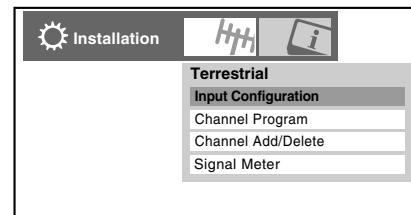

- 4 Press **◀** or **▶** to select the input source (**Cable** or **Antenna**) for the **ANT** input on the TV.



- 5 To save your new settings, highlight **Done** and press **ENTER**. To revert to your original settings, highlight **Cancel** and press **ENTER**.

Chapter 5: Setting up your TV

Programming channels into the TV's channel memory

When you press **CH** or **CH** on the remote control or TV control panel, your TV will stop only on the channels you programmed into the TV's channel memory.

Follow the steps below to program channels into the TV's channel memory.

Programming channels automatically

Your TV can automatically detect all active channels in your area and store them in its memory. After the channels are programmed automatically, you can manually add or erase individual channels in the channel memory.

Note:

- You must configure the antenna input source before programming channels (see page 31).
- If the Antenna input signal type is set to **Cable**, the automatic channel programming process erases channels that were previously programmed into the TV's memory.
- If the Antenna input signal type is set to **Antenna**, the automatic channel programming process adds newly found channels to the existing set of programmed channels (and does NOT erase channels that were previously programmed into the TV's memory.) To remove an Antenna source channel from the memory, you must manually delete it.
- To tune the TV to a channel not programmed in the channel memory, you must use the Channel Number buttons on the remote control.
- Programming channels when the antenna input is configured for **Cable** will take substantially longer than when the antenna input is configured for **Antenna**. This is normal; however, once channel programming is finished, you should not have to repeat the programming process again unless your Cable TV service lineup changes significantly.

To program channels automatically:

- Configure the antenna input source, if you have not already done so (see page 31).
- Press **MENU** and open the **Setup** menu.
- Highlight **Installation** and press **ENTER**.

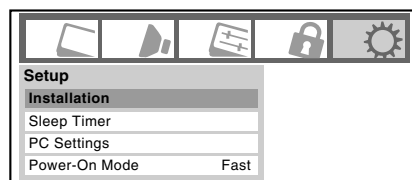

- (A new set of **Installation** menu icons will appear, as shown below.) Open the **Terrestrial** menu, highlight **Channel Program** to bring up the **Start**, and press **ENTER** again to begin channel programming.

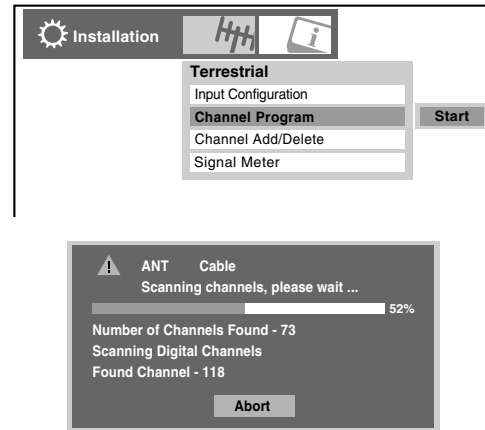

The TV will automatically cycle through all the antenna channels, and store all active channels in the channel memory. While the TV is cycling through the channels, the message “Scanning channels, please wait” appears (as shown above).

- To cancel channel programming, press **EXIT** on the remote control (or highlight **Abort** in the on-screen display and press **ENTER**).

When channel programming is finished, press **CH** or **CH** to view the programmed channels.

Manually adding and deleting channels in the channel memory

After automatically programming channels into the channel memory, you can manually add or delete individual channels.

To add or delete channels in the channel memory:

- Press **MENU** and open the **Setup** menu.
- Highlight **Installation** and press **ENTER**.
- (A new set of **Installation** menu icons will appear, as shown below.) Open the **Terrestrial** menu, highlight **Channel Add/Delete**, and then press **ENTER**.

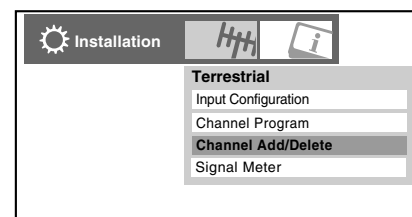

Chapter 5: Setting up your TV

To add a channel to the channel memory:

Highlight the unchecked box next to the channel number you want to add, and then press **ENTER** to check the box.

To manually add digital subchannels on a physical channel:

Use the Channel Numbers and the Dash (**100**) on the remote control to enter the channel number (for example, 56-1).

If the channel is found, the number will be added to the list and the box will be checked.

If the channel is not found, a message will appear.

To remove a channel from the channel memory:

Highlight the checked box next to the channel number you want to remove, and then press **ENTER** to uncheck the box.

To save your new settings:

Highlight **Done** and press **ENTER**.

To revert to your original settings:

Highlight **Cancel** and press **ENTER** before saving.

To remove all channels from the channel memory:

Highlight **Reset** and press **ENTER**, and then highlight **Done** and press **ENTER**.

Channel Add/Delete			
<input type="checkbox"/>	2	--	Analog
<input checked="" type="checkbox"/>	2-1	--	Digital
<input checked="" type="checkbox"/>	2-2	--	Digital
<input type="checkbox"/>	3	--	Analog
<input checked="" type="checkbox"/>	4	--	Analog
<input checked="" type="checkbox"/>	5	--	Digital
<input type="checkbox"/>	6	--	Analog
<input type="checkbox"/>	7	--	Analog
<input checked="" type="checkbox"/>	7-1	--	Digital
<input type="checkbox"/>	8	--	Analog

To remove encrypted channels from the channel memory:

If an encrypted channel is accidentally added to the channel list by programming channels, you can remove the unwanted encrypted (non-viewable) channel while you are channel surfing. When you tune to an encrypted channel, the following message will appear.

Digital Channel Is Encrypted - Press 1 on remote to remove channel

Press "**1**" button while the message is on the screen to remove the unnecessary channel from the channel list.

Labeling channels

A list of common channel labels (logos) for various channels (ABC, CBS, etc.) will be programmed into the TV. You will be able to view and assign these logos from the **Channel Labeling** window. If the desired channel label is not provided in the list, you will be able to manually enter/edit labels using the software keyboard.

To assign channel labels:

- 1 Press **MENU** and open the **Preferences** menu.
- 2 Highlight **Channel Labeling** and press **ENTER**. The **Channel Labeling** window opens.

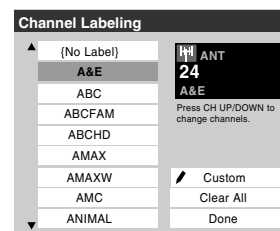
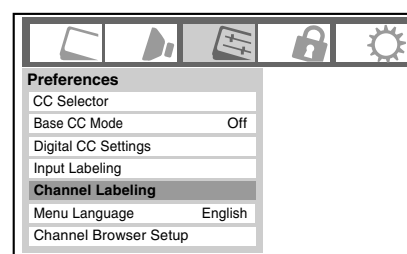

- 3 Press **CH** or **CH** to select the channel you want to label.
- 4 Press **▲▼▶◀** to highlight the desired channel label and press **ENTER**.
- 5 Repeat steps 3 and 4 for other channels.
- 6 To save your settings, highlight **Done** and press **ENTER**.

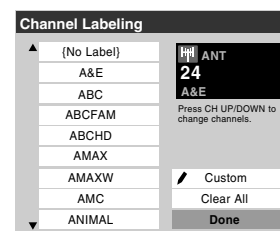

The maximum number of labels that can be stored is 128.

To remove channel labels:

- 1 Open the **Channel Labeling** window.
- 2 Press **CH** or **CH** to select the channel for which you want to remove the label.

(continued)

Chapter 5: Setting up your TV

- 3 Press **▲▼◀▶** to highlight **No Label** and press **ENTER**.

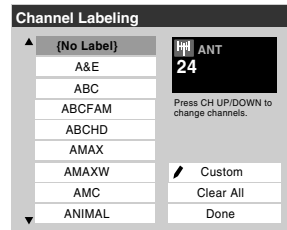

- 4 Repeat steps 2 and 3 for other channels.
5 To save your settings, highlight **Done** and press **ENTER**.

If the desired channel label is not available from the list of presets, you can create a custom label.

To create and assign a custom label:

- 1 Open the **Channel Labeling** window.
- 2 Press **CH** or **CH** to select a channel you want to label.
- 3 Press **▲▼▶** to highlight **Custom** and press **ENTER**.
The software keyboard will appear.

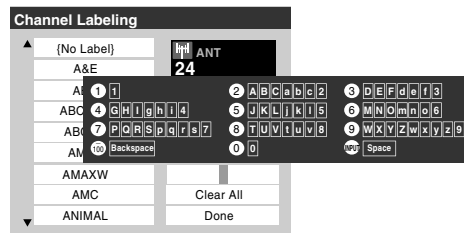

- 4 Repeatedly press the corresponding key on the remote control to highlight the desired character on the on-screen software keyboard.
- 5 The highlighted character is entered after you either press a different key, press **▶** key, or after a two-second pause.
- 6 Repeat steps 4 and 5 until you have entered all desired text.
- 7 When finished, press **ENTER**.
- 8 (New labels will be added to the list in alphabetical order and marked with an icon **✎** to indicate that they are custom.) Highlight the new custom label and press **ENTER** to assign. Assigned channel labels will be displayed in the banner, **Channel Add/Delete** window, and **Channels Block** window.

To delete the custom label:

- 1 Open the **Channel Labeling** window.
- 2 Highlight the label to be deleted and press **100**.

- 3 Highlight **Yes** from the deletion confirmation window and press **ENTER**.

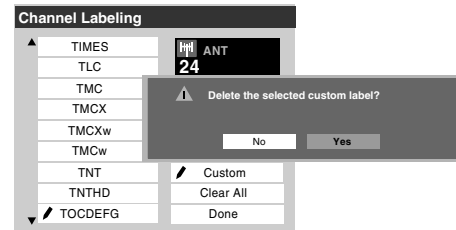

- 4 Highlight **Done** and press **ENTER** to save changes, and go back to the **Channel Labeling** window.

Setting the HDMI™ audio mode

To set the HDMI audio mode:

- 1 Press **MENU** and open the **Audio** menu.
- 2 Highlight **Audio Setup** and press **ENTER**.
- 3 Press **▲** or **▼** to select **HDMI 1 Audio** and then press **◀** or **▶** to select the HDMI 1 audio mode (**Auto**, **Digital**, or **Analog**). (**Auto** is the recommended mode.) See “Connecting an HDMI or DVI device to the HDMI input” (page 19).

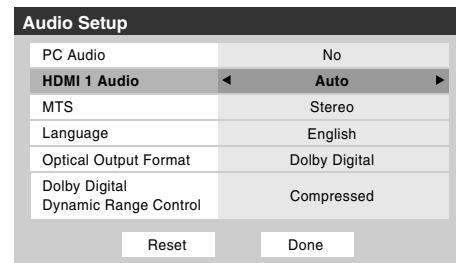

Note: Because the PC and HDMI-1 inputs share the same set of analog audio inputs, the **PC Audio** menu setting influences the **HDMI 1 Audio** menu setting. If **PC Audio** is set to “No,” the **HDMI 1 Audio** setting changes to “Auto.” If **PC Audio** is set to “Yes,” the **HDMI 1 Audio** setting is set to “Digital” and is grayed out in the menu. (Also see item 3 on page 12 and “Setting the PC Audio” on page 54.)

Chapter 5: Setting up your TV

Setting the Power-On Mode feature

You can select either **Power-Saving** or **Fast** mode.

If you select **Power-Saving** mode and you turn off the TV, it can take several seconds for the picture to appear when you turn on the TV again. **Power-Saving** mode saves more power than **Fast** mode. See “Specifications” on page 66 for details.

If you select **Fast** mode and the TV is turned off, the TV will stay in Standby mode for several minutes (see Note below). If the TV is turned on from Standby mode, the full picture appears immediately.

To set the Power-On Mode feature:

- 1 Press **MENU** and open the **Setup** menu.
- 2 Highlight **Power-On Mode** and press **▶**.
- 3 Press **▼** or **▲** to select either **Fast** or **Power-Saving** and press **ENTER**.

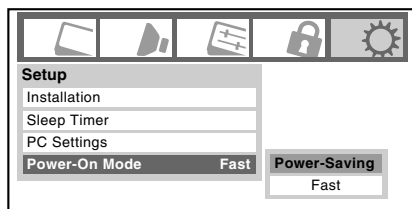

Note: If **Power-On Mode** is set to **Fast** and you turn off the TV, the following will occur for a few minutes:

- The screen (lamp) lights dimly; and
- The fans continue to run.

This is a function of the Power-On Fast Shutdown mode and is not a TV malfunction. If you do not prefer this, set the **Power-On Mode** feature to **Power-Saving**.

When the **Power-On Mode** feature is set to **Power-Saving**, if you repeatedly turn the TV on and off in a short period of time, the useful service life of the lamp may be shorter than the average useful service life (see page 63).

IMPORTANT NOTICE ABOUT HOT LAMP RESTART

When the TV has been powered on long enough for the lamp unit to get hot, it may take several minutes for the picture to appear in the following situations:

- When the Power-On Mode feature is set to Power-Saving and you turn the TV off and then on again within a few minutes; or
- If the TV is on when a short-term power failure, power surge, or other similar power failure occurs, such that the TV loses and regains power within a few minutes.

This is a property of DLP® TV lamp technology and is NOT a sign of malfunction.

If this occurs, the yellow LED on the TV front panel will blink (and the blue LED will be lit solid) until the TV is finished restarting the lamp and the normal picture appears. If both LEDs are blinking, you will need to turn the TV off and then on again to restart the lamp.

Viewing the digital signal meter

You can view the digital signal meter in the ANT digital TV input source only.

To view the digital signal meter:

- 1 Press **MENU** and open the **Setup** menu.
- 2 Highlight **Installation** and press **ENTER**.
- 3 A new set of Installation menu icons will appear, as shown below. Open the **Terrestrial** menu, highlight **Signal Meter**, and press **ENTER**.

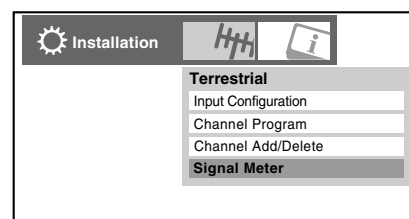

- 4 Press **▲▼◀▶** to select the antenna input and digital channel whose signal you want to check.

Note: The physical digital channel number listed in the Signal Meter screen may not correspond to a virtual TV channel number. Contact your local broadcasters to obtain the RF channel numbers for your local digital stations.

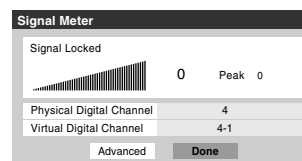

To close the screen and return to the Terrestrial menu:

Highlight **Done** and press **ENTER**.

To return to normal viewing:

Press **EXIT**.

Chapter 5: Setting up your TV

Viewing the system status

To view the system status:

- 1 Press **MENU** and open the **Setup** menu.
- 2 Highlight **Installation** and press **ENTER**.
- 3 A new set of Installation menu icons will appear, as shown below. Open the **System Status** menu, highlight **System Information**, and press **ENTER**.

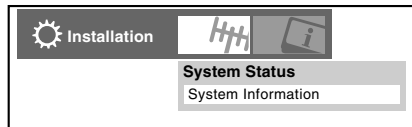

- 4 Press **◀▶** to scroll through the menu bar to select the **Software Version** and view the related information.

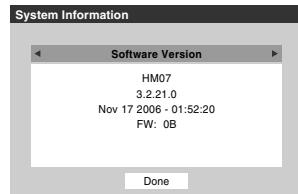

To close the screen and return to the **Installation** menu:

Highlight **Done** and press **ENTER**.

To return to normal viewing:

Press **EXIT**.

Reset Factory Defaults

To reset all settings and channels to their factory default values:

- 1 Press **MENU** and open the **Setup** menu.
- 2 Highlight **Installation** and press **ENTER**. A new set of Installation menu icons will appear.
- 3 Open the **System Status** menu, highlight **System Information**, and press **ENTER**.
- 4 Press **◀▶** to scroll through the menu bar to select **Factory Defaults**.

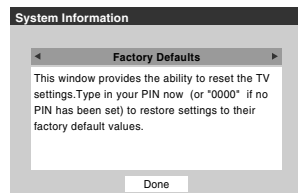

- 5 Enter your PIN code (or 0000 if no PIN code has been set).

- 6 Highlight **Yes** and press **ENTER**. The TV will turn off automatically after a few seconds. After the TV turns off, unplug the TV power cord and then plug it in again to complete the reset process.

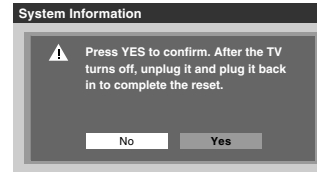

To cancel the reset:

Highlight **No** and press **ENTER**.

Chapter 6: Using the TV's features

Selecting the video input source to view

To select the video input source to view:

- 1 Press **INPUT** on the remote control or TV control panel.
- 2 And then either:
 - a) Press 0–8; or
 - b) Repeatedly press **▲▼** on the remote control and then press **ENTER** to change the input; or
 - c) Repeatedly press **INPUT** on the remote control or TV control panel to change the input.

The current signal source displays in the top right corner of the **Input Selection** screen.

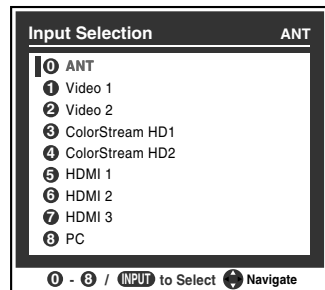

Note:

- You can label the video input sources according to the specific devices you have connected to the TV (see "Labeling the video input sources" at right).
- Sources can also be "hidden" (see "Labeling the video input sources" at right).
- "No Video Signal" will appear randomly on the screen if no signal is received in video input mode.

Labeling the video input sources

You can label each video input source according to the type of device you connected to each source, from the following preset list of labels:

- -- (default label)
- Audio Receiver
- Cable
- Compact Disc
- DTV
- DVD
- Game Console
- HD DVD
- Laser Disk
- Satellite/DSS
- VCR
- Video Recorder
- Hide (to hide an unused input in the **Input Selection** screen)

Note: If you select PC in the **Input Selection** screen, you can choose only "--" or "Hide" as the label.

To label the video input sources:

- 1 Press **MENU** and open the **Preferences** menu.
- 2 Highlight **Input Labeling** and press **ENTER**.
- 3 Press **▲** or **▼** to highlight the video source you want to label.

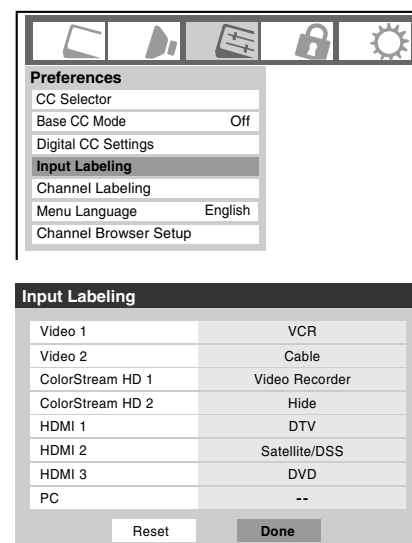

(continued)

Chapter 6: Using the TV's features

- 4 Press ◀ or ▶ to select the desired label for that input source. If a particular input is not used, you can select **Hide** as the label, which will cause that input to be “grayed out” in the Input Selection screen and skipped over when you press (INPUT) on the remote control.
- 5 To save the new input labels, highlight **Done** and press (ENTER).
To revert to the factory default labels, highlight **Reset** and press (ENTER).

Input labeling example:

The screen below left shows the default **Input Selection** screen (with none of the inputs labeled as a specific device). The screen below right is an example of how you could label the inputs if you connected a VCR to VIDEO 1, Cable TV to VIDEO 2, a video recorder to ColorStream HD1, a DTV set-top box to HDMI 1, a satellite/DSS set-top box to HDMI 2, and a DVD player to HDMI 3. Also note that the ColorStream HD2 input is labeled “Hidden,” which means that input will be skipped over when (INPUT) is pressed.

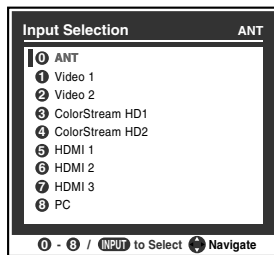

Input Selection screen with no inputs labeled.

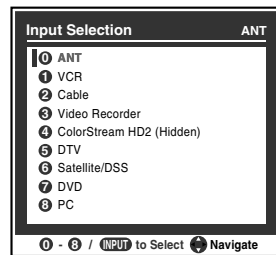

Input Selection screen with all inputs labeled except input 4, which has been hidden.

To clear the input labels:

- 1 Press (MENU) and open the **Preferences** menu.
- 2 Highlight **Input Labeling** and press (ENTER).
- 3 Highlight **Reset** and press (ENTER).

Tuning channels

Tuning channels using the Channel Browser™

The Channel Browser™ provides an easy navigation interface for all your channels and inputs. This feature allows you to:

- Navigate the contents of all of your inputs.
- Keep a list of your favorite channels (see “Favorites Browser,” below).
- Keep a history of the last 32 channels or inputs viewed.
- Quickly surf and tune your recently viewed channels/inputs from the Channel Browser™ History List (illustrated on the next page).
- Surf via Browse mode (to immediately tune channels as you highlight them in the Channel Browser™) or Select mode (to surf over channels in the Channel Browser™ before you select one to tune).
- Quickly change inputs from the Inputs List.

Favorites Browser

The Favorites Browser allows you to quickly set up a favorite channels/inputs list that is integrated into the Channel Browser™.

To add a favorite channel/input:

- 1 Tune to the channel or input.
- 2 Press and hold (FAV BROWSER) for 3 seconds.

Note: Additions are added to the beginning of the Favorites list on the left side of the Channel Browser™.

To delete a favorite channel/input:

- 1 Press (FAV BROWSER) to open the Favorites browser list.
- 2 Highlight the channel or input to delete by pressing (BACK) ◀ or (NEXT) ▶.
- 3 Press and hold (100) for 3 seconds. The channel/input will be removed from the Favorites list.

To set up the Channel Browser™:

- 1 Press (MENU) and open the **Preferences** menu.
- 2 Highlight **Channel Browser Setup** and press (ENTER).
- 3 Press ▲ to highlight **Navigation**, and then press ◀ or ▶ to select either **Browse Mode** or **Select Mode**.

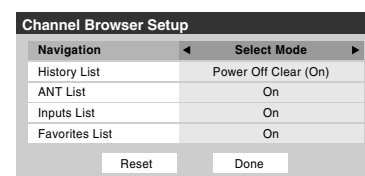

Chapter 6: Using the TV's features

- 4** Press ▼ to highlight **History List**, and then press ◀ or ▶ to select the setting you prefer: either **Power Off Clear (On)**, **On**, or **Off**.

Note: When **History List** is set to **On** and the **Power-On Mode** (see page 35) is in **Fast** mode, the channels and inputs stored in the list will be saved every power on/off cycle. When **History List** is set to **Power Off Clear (On)**, the channels and inputs stored in the list will be cleared with every power on/off cycle of the TV.

- 5** Press ▼ to highlight **ANT List**, and then press ◀ or ▶ to select **On** or **Off**.
- 6** Press ▼ to highlight **Inputs List**, and then press ◀ or ▶ to select **On** or **Off**.
- 7** Press ▼ to highlight **Favorites List**, then press ◀ or ▶ to select **On** or **Off**.
- 8** To save your entries, highlight **Done** and press **ENTER**. To return to factory defaults, highlight **Reset** and press **ENTER**.

To open the Channel Browser™:

- Press **BACK** ◀ or **NEXT** ▶ on the remote control.
- Press **BACK** ◀ to surf backward through the previously tuned 32 channels in the History list, the channels in the ANT channel list, the inputs in the Inputs list, or the favorite channels/inputs in Favorites list.
- Press **NEXT** ▶ to surf forward through the channel History, the ANT channel list, the Inputs list, or the favorite channels/inputs in Favorites list.

Elements of the Channel Browser™

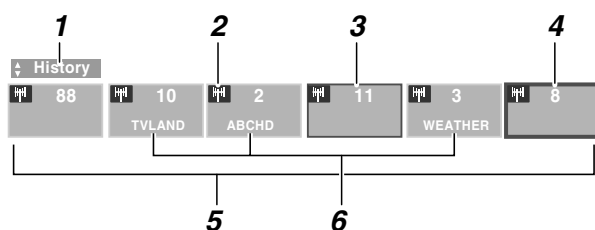

- Current list (**History**, **ANT**, **Inputs**, or **Favorites**)
- Input type
- Channel or input currently being viewed
- Channel or input that is currently highlighted in the browser
- Channels stored in the History List
- Channel labels

To toggle among the available lists:

After opening the Channel Browser™, press ▲ or ▼ to toggle among **History**, **ANT**, **Inputs**, and **Favorites**.

Note:

- The Channel Browser™ opens in **History List** by default. Once another list has been selected, the Channel Browser™ will open in the last selected list.

- If all lists are turned off, pressing **BACK** ◀, **NEXT** ▶, or **FAV BROWSER** will not display the Channel Browser™. If **Favorites List** is turned off, **FAV BROWSER** will have no effect.
- Pressing **FAV BROWSER** will bring up the Channel Browser™ Favorites list regardless of the last selected list in the Channel Browser™.

To tune to a channel or input in Browse mode:

- While watching TV, press **BACK** ◀ or **NEXT** ▶ to open the Channel Browser™ and surf back to a previous item or surf forward to the next item in the list. In **Browse** mode, when you stop on an item in the Channel Browser™, it will be highlighted and the TV will automatically tune to the channel or input.
- Press **EXIT** to close the Channel Browser™.

To tune to a channel or input in Select mode:

- While watching TV, press **BACK** ◀ or **NEXT** ▶ to open the Channel Browser™ and surf back to a previous item or forward to the next item in the list. In **Select** mode, when you stop on an item in the Channel Browser™, it will be highlighted but you must press **ENTER** to tune the TV to the highlighted item.
- Press **ENTER** to tune the TV to the highlighted item.
- Press **EXIT** to close the Channel Browser™.

Adding and clearing channels and inputs in the History List

Adding channels and inputs to the History List:

As a channel or input is tuned, the Channel Browser™ adds it to the History List and displays it on the “right side” of the Channel Browser™. Previously tuned channels/inputs are “shifted” to the left, eventually moving off the left side. Press **BACK** ◀ to surf backward through the previously tuned channels/inputs. Any channel or input that is tuned repeatedly will not be repeated in the History List, but instead is moved to the end of the list on the right side of the Channel Browser™.

The Channel Browser™ will store the following channels:

- All channels that are tuned using the numeric buttons on the remote control.
- All channels that are tuned using **CH** or **CH** on the remote control.

Note: Whenever an item is selected that cannot be tuned (for various reasons), the TV will automatically tune to the previously viewed channel or input.

(continued)

Chapter 6: Using the TV's features



Clearing channels from the History List:

- Reconfiguring the **ANT** input will clear the History List.

Note: See page 31 for details on configuring the antenna input.
- Once 32 channels or inputs are stored in the History List, the oldest item will be removed from the list when a new channel or input is tuned.
- If **History List** in the **Channel Browser Setup** is set to "**Power Off Clear (On)**," turning off the TV will clear the History List.

Tuning to the next programmed channel

To tune to the next programmed channel:

Press  or  on the remote control or TV control panel.

Note: This feature will not work unless you program channels into the TV's channel memory (see page 32).

Tuning to a specific channel (programmed or unprogrammed)

Tuning analog channels:

Press the Channel Number (0–9) on the remote control. For example, to select channel 125, press 1, 2, 5.



Tuning digital channels:

Press the Channel Number (0–9) on the remote control, followed by the dash () button and then the sub-channel number. For example, to select digital channel 125-1, press 1, 2, 5, -, 1.

Note: If a digital channel is not programmed—either through the automatic channel scan (see page 32) or the channel add/delete function (see page 32)—you will have to tune the RF channel using the Channel Number and dash () on the remote control.



Switching between two channels using Channel Return





The Channel Return feature allows you to switch between two channels without entering an actual channel number each time.

- 1 Select the first channel you want to view.
- 2 Select a second channel using the Channel Number buttons (and the dash () button if selecting a digital channel).
- 3 Press  on the remote control. The previous channel will display. Each time you press , the TV will switch back and forth between the last two channels that were tuned.

Note: If you press  from a non-antenna input, the TV will return to the last-viewed input.

Switching between two channels using SurfLock™

The SurfLock™ feature temporarily “memorizes” one channel to the  button, so you can return to that channel quickly from any other channel by pressing . To memorize a channel to the  button:

- 1 Tune the TV to the channel you want to program into the  button.
- 2 Press and hold  for about 2 seconds until the message “Channel Memorized” appears on-screen. The channel has been programmed to the  button.
- 3 You can then change channels repeatedly, and when you press , the memorized channel will be tuned.

The TV will return to the memorized channel one time only. Once you press  and then change channels again, the CH RTN memory will be cleared and the button will function as Channel Return, by switching back and forth between the last two channels that are tuned. This feature also works for external inputs.

Chapter 6: Using the TV's features

Selecting the picture size

You can view many program formats in a variety of picture sizes—**Natural**, **TheaterWide 1**, **TheaterWide 2**, **TheaterWide 3**, **Full**, and **4:3 HD**.

Note: The “picture size” illustrations are examples only. The format of the image (in any of the picture sizes) will vary depending on the format of the signal you are currently watching. Select the picture size that displays the current program the way that looks best to you.

You can save separate picture size preferences for each input on your TV.

To select the picture size using the remote control:

- 1 Press **PIC SIZE** on the remote control.
- 2 While the **Picture Size** screen is open, you can do one of the following to select the desired picture size:
 - Repeatedly press **PIC SIZE**.
 - Press the corresponding Number button (0–5) while the **Picture Size** screen is open.
 - Press **▲** or **▼** while the **Picture Size** screen is open.

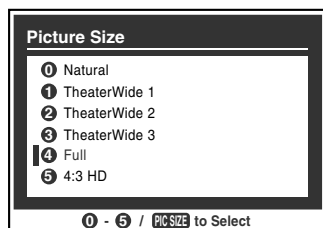

To select the picture size using the menus:

- 1 Select **Picture Size** in the **Theater Settings** menu.
- 2 Press **◀** or **▶** to select the desired picture size setting.
- 3 Highlight **Done** and press **ENTER**.

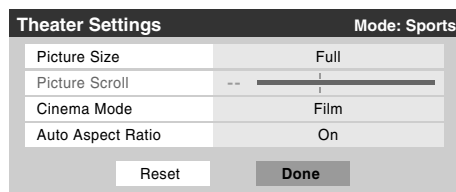

Note: Some of the picture sizes may not be available depending on the receiving signal format (those will be “grayed out” in the **Picture Size** screen).

Using these functions to change the picture size (i.e., changing the height/ width ratio) for any purpose other than your private viewing may be prohibited under the Copyright Laws of the United States and other countries, and may subject you to civil and criminal liability.

Note: If you select one of the TheaterWide® picture sizes, the top and bottom edges of the picture (including subtitles or captions) may be hidden. To view the hidden edges, either scroll the picture (**TheaterWide 2** and **3** only) or try viewing the program in **Full** or **Natural** picture size.

Natural picture size

- The image is displayed close to its originally formatted proportion. Some program formats will display with sidebars and/or bars at the top and bottom.

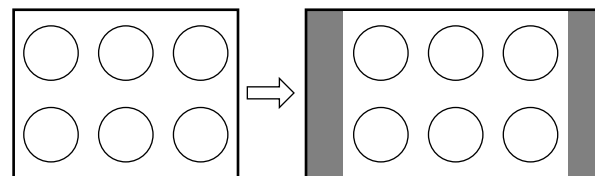

Natural picture size example

TheaterWide 1 picture size (for 4:3 format programs)

- The center of the picture remains close to its original proportion, but the left and right edges are stretched wider to fill the screen.

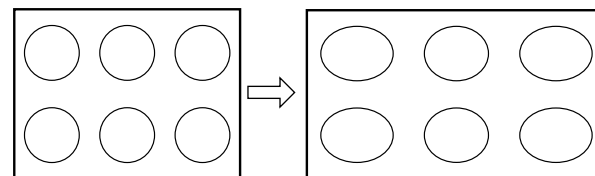

TheaterWide 1 picture size example

TheaterWide 2 picture size (for letter box programs)

- The picture is stretched wider to fill the width of the screen, but only slightly stretched taller.
- The top and bottom edges of the picture may be hidden. To view the hidden areas, see “Scrolling the TheaterWide® picture” (page 42).

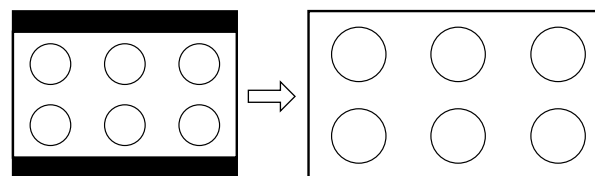

TheaterWide 2 picture size example

Chapter 6: Using the TV's features

TheaterWide 3 picture size (for letter box programs with subtitles)

- The picture is stretched wider to fill the width of the screen, but only slightly stretched taller.
- The top and bottom edges are hidden. To view the hidden areas (such as subtitles or captions), see “Scrolling the TheaterWide® picture.”

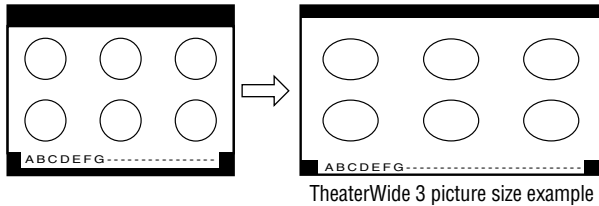

Full picture size (for 16:9 [480i, 480p] source programs only)

- If receiving a squeezed 4:3 format program, the picture is stretched wider to fill the width of the screen, but not stretched taller.
- None of the picture is hidden.

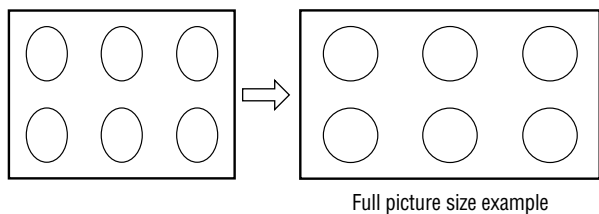

4:3 HD picture size (for 720p, 1080i, and 1080p program sources only)

- Sidebars fill the empty vertical spaces.
- Picture is not distorted from original size.

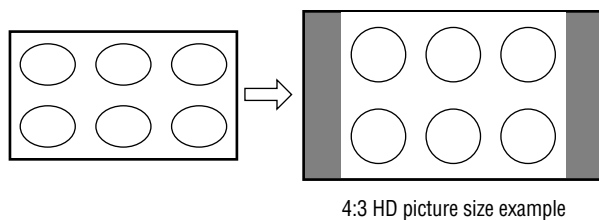

Scrolling the TheaterWide® picture (TheaterWide 2 and 3 only)

You can set separate scroll settings for the TheaterWide 2 and TheaterWide 3 modes for each input.

To set the scroll settings:

- 1 Press **MENU** and open the **Video** menu.
- 2 Highlight **Theater Settings** and press **ENTER**.

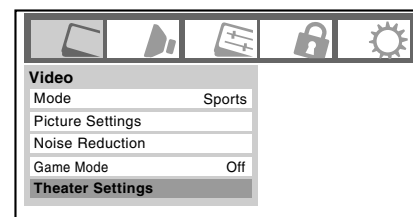

- 3 In the **Picture Size** field, select either **TheaterWide 2** or **TheaterWide 3** (you cannot scroll in any other mode).
- 4 Press **▼** to highlight the **Picture Scroll** field.
- 5 Press **◀** or **▶** to scroll the picture up and down as needed, from -10 to +20.

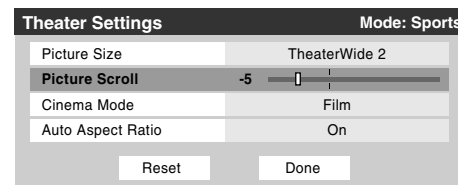

- 6 To save the new settings, highlight **Done** and press **ENTER**. To revert to the factory defaults, highlight **Reset** and press **ENTER**.

Chapter 6: Using the TV's features

Using the auto aspect ratio feature

When the auto aspect ratio feature is set to **On**, the TV will automatically select the picture size when one of the following input sources is received:

- A 480i signal from the **VIDEO 1**, **VIDEO 2**, **ColorStream HD-1**, or **ColorStream HD-2** input.
- A 480i, 480p, 720p, 1080i, 1080p, or VGA signal from the **HDMI** input.

Aspect ratio of signal source	Automatic aspect size (automatically selected when Auto Aspect is On)
4:3 normal	Natural (with sidebars)
4:3 letter box	TheaterWide 2
16:9 full	Full
Not defined (no ID-1 data or HDMI aspect data)	The current picture size you set under "Selecting the picture size" on page 41.

Note: The auto aspect ratio feature is not applicable to antenna or cable input sources.

To turn on the auto aspect ratio feature:

- 1 Press **MENU** and open the **Video** menu.
- 2 Highlight **Theater Settings** and press **ENTER**.
- 3 In the **Auto Aspect Ratio** field, select **On**.

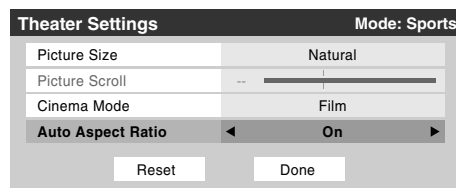

- 4 To save the new settings, highlight **Done** and press **ENTER**. To revert to the factory defaults, highlight **Reset** and press **ENTER**.

To turn off the auto aspect ratio feature:

Select **Off** in step 3 above.

Selecting the cinema mode (480i and 1080i signals)

When you view a DVD (3:2 pulldown processed) from a DVD player connected to the **VIDEO 1**, **VIDEO 2**, **ColorStream HD-1**, **ColorStream HD-2** (component video), or **HDMI** inputs on the TV, smoother motion can be obtained by setting the **Cinema Mode** to **Film**.

To set the Cinema Mode to Film:

- 1 Press **MENU** and open the **Video** menu.
- 2 Highlight **Theater Settings** and press **ENTER**.
- 3 In the **Cinema Mode** field, select **Film**.

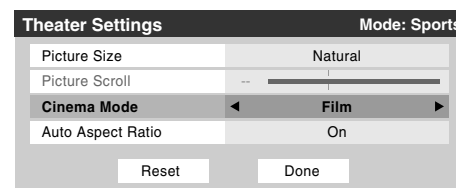

- 4 To save the new settings, highlight **Done** and press **ENTER**. To revert to the factory defaults, highlight **Reset** and press **ENTER**.

To set the Cinema Mode to Video:

Select **Video** in step 3 above.

Chapter 6: Using the TV's features

Adjusting the picture

Selecting the picture mode

You can select your desired picture settings from four different modes, as described below.

Mode	Picture Quality
Sports	Bright and dynamic picture (factory setting)
Standard	Standard picture settings (factory setting)
Movie	Lower contrast for darkened room (factory setting)
Preference	Your personal preferences

To select the picture mode:

Press **PIC MODE** on the remote control.

The following popup menu appears on-screen.

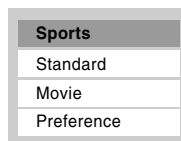

Press **▲** or **▼** to select the picture mode you prefer and press **ENTER**.

To select the picture mode using the menu system:

- 1 Press **MENU** and open the **Video** menu.
- 2 Highlight **Mode** and press **ENTER**.

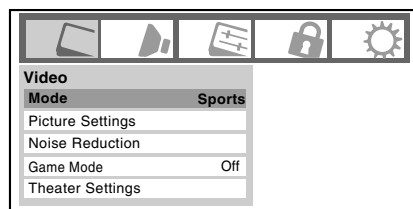

- 3 Press **▲** or **▼** to select the picture mode you prefer and press **ENTER**.

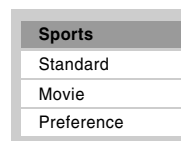

Note: The picture mode you select affects the current input only. You can select a different picture mode for each input.

Adjusting the picture quality

You can adjust the picture quality (Contrast, Brightness, Color, Tint, and Sharpness) to your personal preferences.

Selection	Pressing ◀	Pressing ▶
Contrast	lower	higher
Brightness	darker	lighter
Color	paler	deeper
Tint	reddish	greenish
Sharpness	softer	sharper

To adjust the picture quality:

- 1 Press **MENU** and open the **Video** menu.
- 2 Highlight **Picture Settings** and press **ENTER**.
- 3 Press **▲** or **▼** to select the picture quality you want to adjust (**Contrast**, **Brightness**, **Color**, **Tint**, or **Sharpness**), and then press **◀** or **▶** to adjust the setting, as described in the table above.

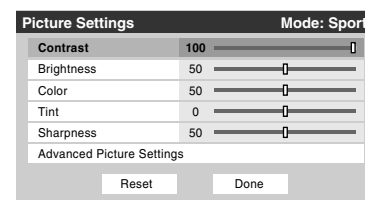

- 4 To save the new settings, highlight **Done** and press **ENTER**. You can use any of the picture modes (see “Selecting the picture mode,” above left) as a starting point for adjusting the picture settings. To revert back to the base mode that you began adjusting the picture settings from, highlight **Reset** and press **ENTER**.

The picture qualities you adjusted are automatically saved in the **Preference** mode (see “Selecting the picture mode,” above left) until **Reset** is selected.

Chapter 6: Using the TV's features

Using the closed caption mode

Base closed captions

The closed caption mode has two options:

- **Captions**—An on-screen display of the dialogue, narration, and sound effects of TV programs and videos that are closed captioned (usually marked “CC” in program guides).
- **Text**—An on-screen display of information not related to the current program, such as weather or stock data (when provided by individual stations).

To view captions or text:

- 1 Press **MENU** and open the **Preferences** menu.
- 2 Highlight **Base CC Mode** and press **▶**.
- 3 Press **▲** or **▼** to select the desired closed caption mode and press **ENTER**.

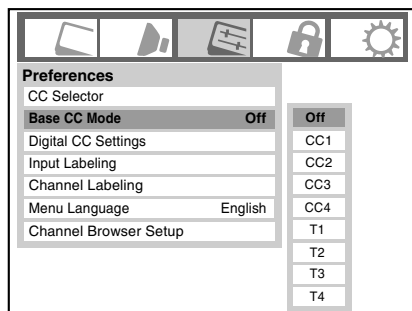

- **To view captions:** Highlight **CC1**, **CC2**, **CC3**, or **CC4**. (**CC1** displays translation of the primary language in your area.)



Note: If the program or video you selected is not closed captioned, no captions will display on-screen.

- **To view text:** Highlight **T1**, **T2**, **T3**, or **T4**.

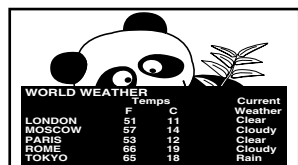

Note: If text is not available in your area, a black rectangle may appear on screen. If this happens, set the Base CC Mode to **Off**.

- **To turn off the closed caption mode:** Select **Off** in step 3 above.

Note: A closed caption signal may not display in the following situations:

- When a videotape has been dubbed
- When the signal reception is weak
- When the signal reception is non-standard

Digital CC Settings

You can customize the closed caption display characteristics by changing the background color, text size, type, edge, and color.

Note:

- This feature is available for digital channels only.
- You cannot set the Caption Text and Background as the same color.

To customize the closed captions:

- 1 Press **MENU** and open the **Preferences** menu.
- 2 Highlight **Digital CC Settings** and press **ENTER**.
- 3 Press **▲** or **▼** to highlight the characteristic you want to change, and then press **◀** or **▶** to select the format for that characteristic (see table below).

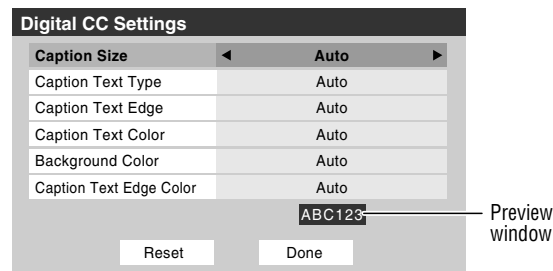

- 4 To save the new settings, highlight **Done** and press **ENTER**. To revert to the factory defaults, highlight **Reset** and press **ENTER**.

Caption Size	Auto, Small, Standard, Large
Caption Text Type	Auto, Default, Mono w. Serif, Prop. w. Serif, Mono w/o Serif, Prop. w/o Serif, Casual, Cursive, Small Capitals
Caption Text Edge	Auto, None, Raised, Depressed, Uniform, Left Drop Shadow, Right Drop shadow
Caption Text Color	Auto, Black, White, Red, Green, Blue, Yellow, Magenta, Cyan
Background Color	Auto, Black, White, Red, Green, Blue, Yellow, Magenta, Cyan
Caption Text Edge Color	Auto, Black, White, Red, Green, Blue, Yellow, Magenta, Cyan

Chapter 6: Using the TV's features

CC Selector

You can use the **CC Selector** to temporarily override the default analog caption mode (set in **Base CC Mode**) for a particular channel. However, once you change to another analog channel, the closed caption setting will automatically change back to the current **Base CC Mode** setting.

You can also use the **CC Selector** to select digital closed caption services (if available). When such services are not available, the **CC Selector** presents a default list of services. If the selected service is not available, the next best service will be used instead.

To select closed captions:

- 1 Press **MENU** and open the **Preferences** menu.
- 2 Highlight **CC Selector** and press **ENTER**.

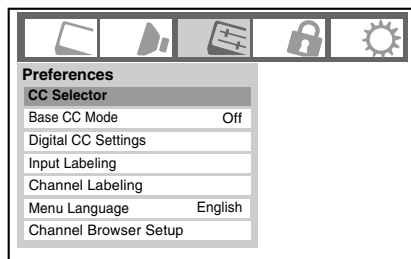

- 3 Press **▲** or **▼** to select **Closed Caption**, and then press **◀** or **▶** to select the desired service.



- 4 Press **EXIT**.

Adjusting the audio

Muting the sound

Press **MUTE** to partially reduce (1/2 MUTE) or turn off (MUTE) the sound. Each time you press **MUTE**, the mute mode will change in the following order:



If the closed caption mode is set to **Off** when you select “MUTE” mode, the closed caption feature is automatically activated. To mute the audio without automatically activating the closed caption feature, use **VOL** to set the volume to 0. See “Using the closed caption mode” (page 45) for more information on closed caption modes.

Using the digital audio selector

You can use the **Digital Audio Selector** to conveniently switch between audio tracks on a digital channel (for those channels that have multiple audio tracks). This temporarily overrides the audio track chosen by the language option under **Audio Setup** (“Selecting stereo/SAP broadcasts” on page 47).

To use the digital audio selector:

- 1 Press **MENU** and open the **Audio** menu.
- 2 Highlight **Digital Audio Selector** and press **ENTER**.

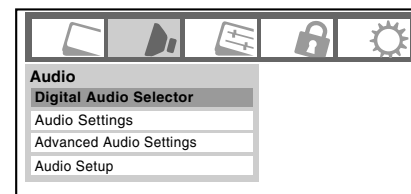

- 3 Press **▲** or **▼** to select **Audio**, and then press **◀** or **▶** to select the desired service.



- 4 Press **EXIT**.

Chapter 6: Using the TV's features

Selecting stereo/SAP broadcasts

The multi-channel TV sound (MTS) feature allows you to output high-fidelity stereo sound. MTS also can transmit a second audio program (SAP) containing a second language, music, or other audio information (when provided by individual stations).

When the TV receives a stereo or SAP broadcast, the word "STEREO" or "SAP" appears on-screen when **RECALL** is pressed. The MTS feature is not available when the TV is in VIDEO mode.

To listen to stereo sound:

- 1 Press **MENU** and open the **Audio** menu.
- 2 Highlight **Audio Setup** and press **ENTER**.

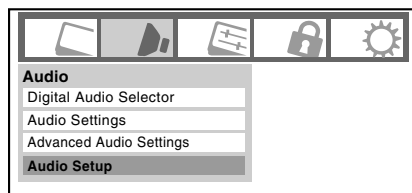

- 3 In the **MTS** field, select **Stereo**.

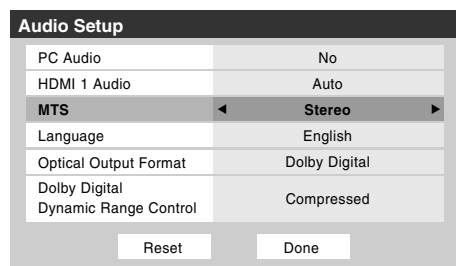

- 4 To save the new settings, highlight **Done** and press **ENTER**. To reset the settings to the factory defaults, highlight **Reset** and press **ENTER**.

Note:

- You can typically leave the TV in **Stereo** mode because it will automatically output the type of sound being broadcast (stereo or monaural).
- If the stereo sound is noisy, select **Mono** to reduce the noise.

To listen to an alternate language on an ATSC digital station (if available):

Highlight the **Language** field in step 3 above, and then press **◀** or **▶** to select the language you prefer.

To listen to a second audio program on an analog station (if available):

Select **SAP** in step 3 above.

Note:

- A second audio program (SAP) can be heard only on those TV stations that offer it. For example, a station might broadcast another language as a second audio program. If you have SAP on, you will see the current program on the screen but hear the other language instead of the program's normal audio.
- If you have SAP on and the station you are watching is not broadcasting a second audio program, the station's normal audio will be output. However, occasionally there is no sound at all in **SAP** mode. If this happens, set the **MTS** feature to **Stereo** mode.

Adjusting the audio quality

You can adjust the audio quality by adjusting the bass, treble, and balance.

To adjust the audio quality:

- 1 Press **MENU** and open the **Audio** menu.
- 2 Highlight **Audio Settings** and press **ENTER**.
- 3 Press **▼** or **▲** to highlight the item you want to adjust (**Bass**, **Treble**, or **Balance**).

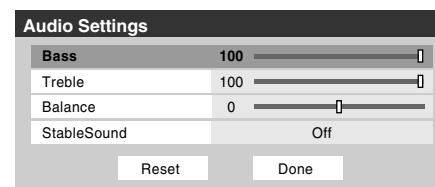

- 4 Press **◀** or **▶** to adjust the level.
 - **◀** makes the bass or treble weaker or increases the balance in the left channel (depending on the item selected).
 - **▶** makes the bass or treble stronger or increases the balance in the right channel (depending on the item selected).
- 5 To save the new settings, highlight **Done** and press **ENTER**. To reset the settings to the factory defaults, highlight **Reset** and press **ENTER**.

Chapter 6: Using the TV's features

Using the StableSound® feature

The StableSound® feature limits the highest volume level to prevent extreme changes in volume when the signal source changes (for example, to prevent the sudden increase in volume that often happens when a TV program switches to a commercial).

To turn on the StableSound® feature:

- 1 Press **MENU** and open the **Audio** menu.
- 2 Highlight **Audio Settings** and press **ENTER**.
- 3 In the **StableSound** field, select **On**.

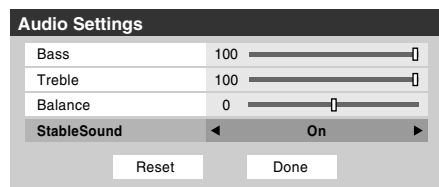

- 4 To save the new settings, highlight **Done** and press **ENTER**. To revert to the factory defaults, highlight **Reset** and press **ENTER**.

Note: The **RESET** function returns your audio adjustments to the following factory settings:

Bass center (50)
 Treble center (50)
 Balance center (0)
 StableSound . . Off

To turn off the StableSound feature:

Select **Off** in step 3 above.

Selecting the optical audio output format

You can use this feature to select the optical audio output format when you connect a Dolby Digital decoder or other digital audio system to the **Optical Audio Out** terminal on the TV (see “Connecting a digital audio system” on page 20).

To select the optical audio output format:

- 1 Press **MENU** and open the **Audio** menu.
- 2 Highlight **Audio Setup** and press **ENTER**.

- 3 In the **Optical Output Format** field, select either **Dolby Digital** or **PCM**, depending on your device.

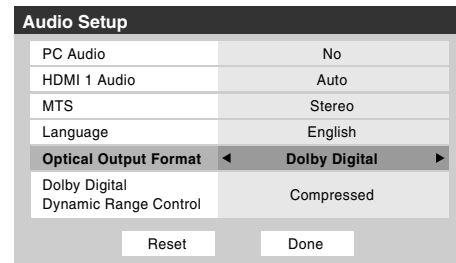

- 4 To save the new settings, highlight **Done** and press **ENTER**. To revert to the factory defaults, highlight **Reset** and press **ENTER**.

Using the Dolby® Digital Dynamic Range Control feature

This dynamic range control feature causes the ATSC dynamic range to be further compressed, allowing you to switch from ATSC to analog broadcasts at the same dynamic range.

To use the Dolby Digital Dynamic Range Control:

- 1 Press **MENU** and open the **Audio** menu.
- 2 Highlight **Audio Setup** and press **ENTER**.
- 3 In the **Dolby Digital Dynamic Range Control** field, select **Compressed**. When **Standard** is selected, the audio is output with minimal compression.

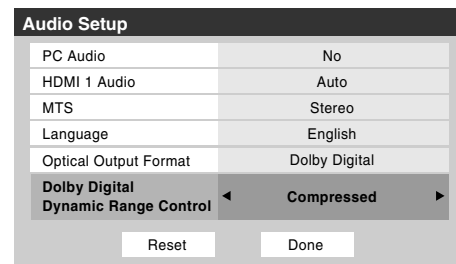

- 4 To save the new settings, highlight **Done** and press **ENTER**. To revert to the factory defaults, highlight **Reset** and press **ENTER**.

Note:

- This item will be grayed out for NTSC signals, Video, ColorStream, and PC inputs.
- The Dolby Digital Dynamic Range Control will function in relation to Optical Output Format (PCM mode).

Chapter 6: Using the TV's features

Using the Locks menu

The Locks menu includes the Enable Rating Blocking, Edit Rating Limits, Channels Block, Input Lock, Front (control) Panel Lock, and New PIN Code features. You can use these features after entering the correct PIN code.

Entering the PIN code

- 1 Press **MENU** and highlight the **Locks** menu icon.

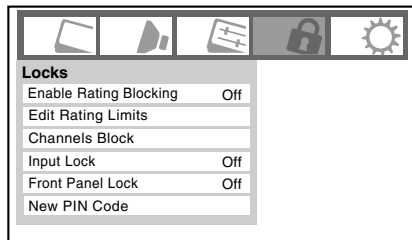

- 2 Press **▼**, which displays the PIN code entry screen.
 - The **Lock System** screen (below) appears if a PIN code has not been stored. Press the Channel Number buttons to enter a new four-digit code, enter the code a second time to confirm, and press **ENTER**.

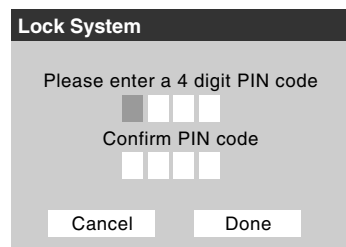

- The **Locks/Active** screen (below) appears if the PIN code is already stored. Use the Number buttons to enter your four-digit code and press **ENTER**.

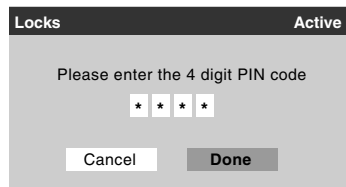

If the wrong PIN code is entered, the message "Incorrect PIN code, please try again!" appears. Highlight **Retry** and press **ENTER**. Enter the code again and press **ENTER**.

When the correct PIN code is entered, the **Locks** menu opens.

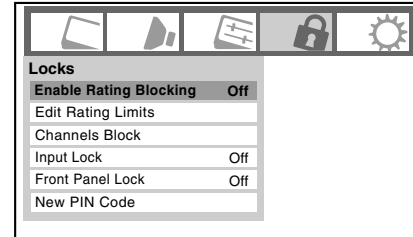

If you cannot remember your PIN code

While the PIN code entering screen is displayed, press **RECALL** four times within five seconds. The PIN code will be cleared and you can enter a new PIN code.

Changing your PIN code

- 1 Press **MENU** and highlight the **Locks** menu icon.
- 2 Press **▼** to display the PIN code entering screen.
- 3 Enter your four-digit PIN code and press **ENTER**.
- 4 Press **▼** to highlight **New PIN Code** and press **ENTER**.

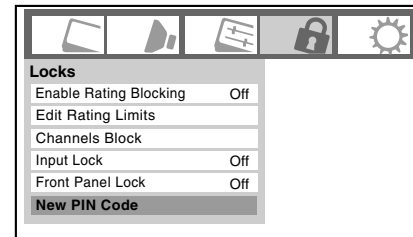

- 5 Press the Number buttons to enter a new four-digit code. Reenter the PIN code to confirm it.
- 6 Press **ENTER**. The new PIN code is now active.

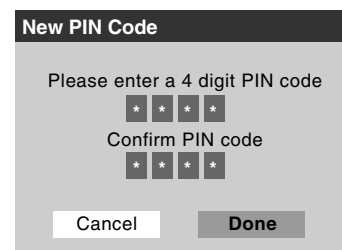

Chapter 6: Using the TV's features

Blocking TV programs and movies by rating (V-Chip)

Some TV programs and movies include signals that classify the content of the program (violence, sex, dialog, language). The V-Chip feature in this TV detects the signals and blocks the programs according to the ratings you select. (For rating descriptions, see the tables on the next page.)

Note: Rating blocking is a function of the V-Chip feature in this TV, which supports the U.S. V-Chip system only.

To block and unblock TV programs and movies:

- 1 Press **MENU** and highlight the **Locks** menu icon.
- 2 Press **▼** to display the PIN code entering screen.
- 3 Enter your four-digit PIN code and press **ENTER**.
- 4 Press **▼** to highlight **Enable Rating Blocking**.
- 5 Press **▶** and **▼** to select **On**, and then press **ENTER**.

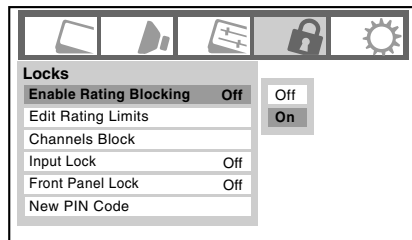

- 6 Press **▼** to highlight **Edit Rating Limits** and press **ENTER**. The **Edit Rating Limits** screen (below) appears.
- 7 Press **▲▼◀▶** and then press **ENTER** to select the level of blocking you prefer. A box with an "X" is a rating that will be blocked. As you highlight a rating, a definition for the rating appears at the bottom of the screen.
- 8 When done selecting the ratings you want to block, highlight **Done** and press **ENTER**.

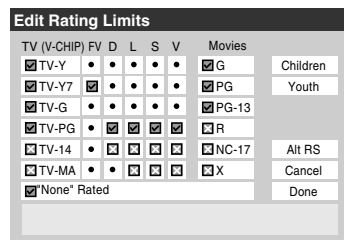

Downloading an additional rating system for blocking TV programs and movies

In the future, an additional rating system may become available for use in selectively blocking programs.

Note: The currently tuned station must be receiving a digital signal before an additional rating system can be downloaded.

To download the additional rating system (if available):

- 1 Press **MENU** and highlight the **Locks** menu icon.
- 2 Press **▼** to display the PIN code entering screen.
- 3 Enter your four-digit PIN code and press **ENTER**.
- 4 Press **▼** to highlight **Enable Rating Blocking**.
- 5 Press **▶** and **▼** to select **On**, and press **ENTER**.
- 6 Press **▼** to highlight **Edit Rating Limits** and press **ENTER**. The **Edit Rating Limits** screen appears.
- 7 Highlight **Alt RS** and press **ENTER**. The **Edit Alternate Ratings** screen will appear.

Note:

- The **Alt RS** button will only be available if an additional rating system is currently available.
- It may take several minutes for the TV to download the additional rating system.
- The information displayed in the **Alternate Ratings** screen will depend on the configuration of the additional rating system available at the time of download.

- 8 Press **▲▼◀▶** and then press **ENTER** to select the level of blocking you prefer. A box with an "X" is a rating that will be blocked.
- 9 When you are finished selecting the ratings you want to block, highlight **Done** and press **ENTER**.
- 10 In the **Edit Rating Limits** screen, highlight **Done** and press **ENTER**.

Note:

- The additional rating system can only be downloaded one time. You will not be able to download any updates to the rating system should such updates become available.
- The additional rating system is not designed, transmitted, or controlled by the TV or Toshiba, nor is the availability of an additional rating system determined or controlled by Toshiba. Similarly, the rating of programs in an additional rating system is not determined, transmitted, or controlled by the TV or Toshiba.
- The additional rating system is an evolving technology; therefore, availability, content, and format may vary.

Chapter 6: Using the TV's features

Independent rating system for broadcasters	
Ratings	Description and Content themes
TV-MA	Mature Audience Only (This program is specifically designed to be viewed by adults and therefore may be unsuitable for children under 17.) L) Crude or indecent language S) Explicit sexual activity V) Graphic violence
TV-14	Parents Strongly Cautioned (This program contains some material that many parents would find unsuitable for children under 14 years of age.) D) Intensely suggestive dialog L) Strong, coarse language S) Intense sexual situations V) Intense violence
TV-PG	Parental Guidance Suggested (This program contains material parents may find unsuitable for younger children.) D) Some suggestive dialog L) Infrequent coarse language S) Some sexual situations V) Moderate violence
TV-G	General Audience (Most parents would find this program suitable for all ages.)
TV-Y7, TV-Y7FV	Directed to Older Children (This program is designed for children age 7 and above. Note: Programs in which fantasy violence may be more intense or more combative than other programs in this category are designated TV-Y7FV.)
TV-Y	All Children (This program is designed to be appropriate for all children.)

Independent rating system for movies	
Ratings	Description and Content themes
X	X-rated (For adults only)
NC-17	Not intended for anyone 17 and under
R	Restricted (Under 17 requires accompanying parent or adult)
PG-13	Parents Strongly Cautioned (Some material may be inappropriate for children under 13)
PG	Parental Guidance Suggested (Some material may not be suitable for children)
G	General Audience (Appropriate for all ages)

Note:

- If you place an "X" in the box next to "None Rated," programs rated "None" will be blocked; however, programs that do not provide any rating information will not be blocked.
- To display the rating of the program you are watching, press **RECALL** on the remote control. If it is rated "None," the word "NONE" appears in the **RECALL** screen (as shown below right). If rating information is not provided, no rating will appear in the **RECALL** screen.

TV - PG L V

NONE

Blocking channels

With the Channels Block feature, you can block specific channels. You will not be able to tune blocked channels unless you unlock them.

To block channels:

- Press **MENU** and highlight the **Locks** menu icon.
- Press **▼** to display the PIN code entering screen.
- Enter your four-digit PIN code and press **ENTER** (see page 49).
- Press **▼** to highlight **Channels Block** and then press **ENTER**.
A list of the channels available for that input will be displayed along with the call letters for each channel, if available.

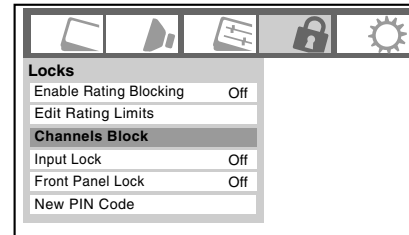

- Press **▲▼** to highlight the channel you want to block and press **ENTER**, which puts an "X" in the box next to that channel.

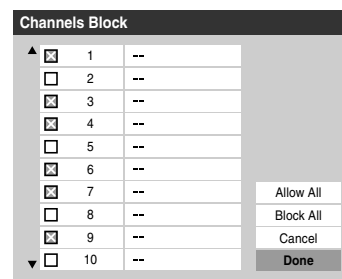

- Repeat step 5 for other channels you want to block.
- Highlight **Done** and press **ENTER**.

To unblock individual channels:

In step 5 above, press **▲▼** to highlight the channel you want to unblock, press **ENTER** to remove the "X" from the box, highlight **Done** and press **ENTER**.

(continued)

Chapter 6: Using the TV's features

To block all channels at once:

Highlight **Block All** in step 5 on previous page and then highlight **Done** and press **ENTER**.

To unblock all locked channels at once:

Highlight **Allow All** in step 5 on previous page and then highlight **Done** and press **ENTER**.

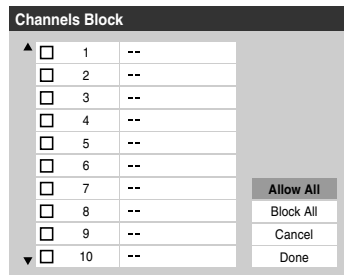

Unlocking programs temporarily

If you try to tune the TV to a program that exceeds the rating limits you set, the TV will enter program lock mode and the following message will appear on-screen:

This program exceeds the rating limit you set.
Push 'mute' to enter PIN.

You can either temporarily unlock the program or select an unlocked program to watch.

To temporarily unlock the program:

- 1 Press **MUTE**.
- 2 Enter your four-digit PIN code and press **ENTER**. If the correct code is entered, the program lock mode is released and the normal picture appears. All locking is disabled until the TV is turned off, and will be enabled when the TV is turned on again.

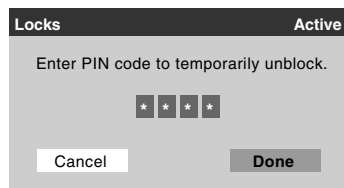

Using the input lock feature

You can use the Input Lock feature to lock the video inputs (**VIDEO 1, VIDEO 2, ColorStream HD-1, ColorStream HD-2, HDMI 1, HDMI 2, HDMI 3** and **PC**) and channels 3 and 4. You will not be able to view the input sources or channels until you unlock the inputs.

To lock/unlock the video inputs:

- 1 Press **MENU** and highlight the **Locks** menu icon.
 - 2 Press **▼** to display the PIN code entering screen.
 - 3 Enter your four-digit PIN code and press **ENTER**.
 - 4 Press **▼** to highlight **Input Lock** and press **▶**.
 - 5 Press **▲** or **▼** to select the level of video input locking you prefer, as described below.
 - Video:** Locks VIDEO 1, VIDEO 2, ColorStream HD1/HD2, HDMI 1, HDMI 2, HDMI 3, and PC.
 - Video+:** Locks VIDEO 1, VIDEO 2, ColorStream HD1/HD2, HDMI 1, HDMI 2, HDMI 3, PC and channels 3 and 4.
- Select **Video+** if you play video tapes via an ANT input.

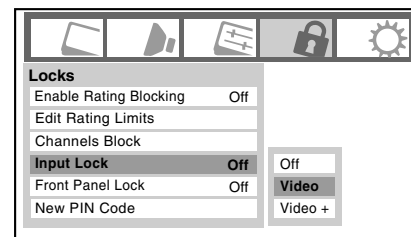

- 6 Press **ENTER**.
 - Off:** Unlocks all video inputs and channels 3 and 4.

Chapter 6: Using the TV's features

Using the control panel lock feature

You can lock the control panel to prevent your settings from being changed accidentally (by children, for example). When the control panel lock is **On**, none of the controls on the TV control panel will operate except **POWER**.

To lock the control panel:

- 1 Press **MENU** and highlight the **Locks** menu icon.
- 2 Press **▼** to display the PIN code entering screen.
- 3 Enter your four-digit PIN code and press **ENTER**.
- 4 Press **▼** to highlight **Front Panel Lock**.
- 5 Press **▶** and **◀** or **▶** to highlight **On** and press **ENTER**. When the control panel is locked and any button on the control panel (except **POWER**) is pressed, the message "Not Available" appears.

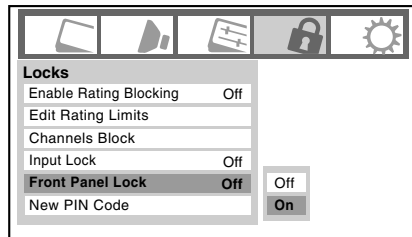

To unlock the control panel:

Highlight **Off** in step 5 above, or press and hold the **VOLUME –** button on the TV control panel for about 10 seconds until the volume icon appears.

Using the PC settings feature

You can view an image from a PC on the TV screen.

When a PC is connected to the TV's PC IN terminal, you can use the PC Settings feature to make adjustments to the image. If the edges of the picture are cut off, readjust the **Horizontal Position** and **Vertical Position**. If the picture is affected by interference, readjust the **Clock Phase** and **Sampling Clock**.

To adjust the PC settings:

- 1 Repeatedly press **INPUT** to select PC input mode (see "Selecting the video input source to view" page 37).
- 2 Press **MENU** and open the **Setup** menu.
- 3 Highlight **PC Settings** and press **ENTER**.

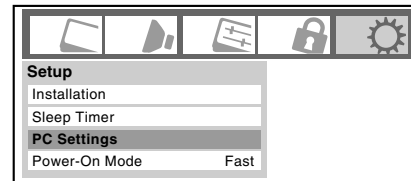

Note: If a PC is not connected or there is no pc input signal, this feature will be grayed out in the **Setup** menu.

- 4 Press **▲** or **▼** to highlight the item you want to adjust.
- 5 Press **◀** or **▶** to make the appropriate adjustments.

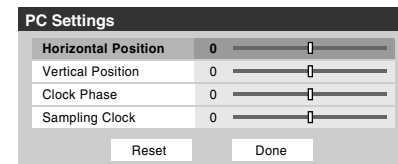

Note: The screen is disrupted momentarily when adjusting the PC settings. This is not a sign of malfunction.

- **Horizontal Position:**
Moves the picture left/right.
The adjustment range is within ± 10 from center.*
- **Vertical Position:**
Moves the picture up/down.
The adjustment range is within ± 10 from center.*
- **Clock Phase:**
Helps to reduce noise and sharpen the picture.
The adjustment range is within ± 4 from center.*
- **Sampling Clock:**
Helps to reduce noise and minimize periodic vertical stripes on the screen.
The adjustment range is within ± 5 from center.*

* The default settings may vary depending on the input signal format.

Chapter 6: Using the TV's features

Setting the PC Audio

This function allows you to output the sound from your PC (if connected) or mute the sound from your PC and output the sound from your HDMI (DVI) connection. (see page 21)

To set the PC Audio:

- 1 Press **MENU** and open the **Audio** menu.
- 2 Highlight **Audio Setup** and press **ENTER**.
- 3 Press **▲** or **▼** to select **PC Audio** and then press **◀** or **▶** to select **No** or **Yes**.

Yes: Outputs the sound from your PC.

No: Mutes the sound from your PC, and outputs the sound from the HDMI-1 connection.

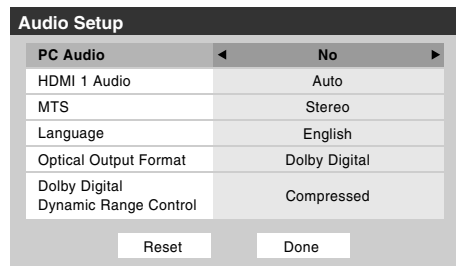

Note: Because the PC and HDMI-1 inputs share the same set of analog audio inputs, the **PC Audio** menu setting influences the **HDMI 1 Audio** menu setting. If **PC Audio** is set to "No," the **HDMI 1 Audio** setting changes to "Auto." If **PC Audio** is set to "Yes," the **HDMI 1 Audio** setting is set to "Digital" and is grayed out in the menu. (Also see item 3 on page 12 and "Setting the HDMI™ Audio mode" on page 34.)

Setting the sleep timer

You can set the sleep timer to turn off the TV after a set length of time (maximum of 180 minutes).

To set the sleep timer using the remote control:

Press **SLEEP** on the remote control to set the length of time until the TV turns off. Repeatedly press **SLEEP** to increase the time in 10-minute increments, or press **▲** or **▼** to increase or decrease the time in 10-minute increments, to a maximum of 180 minutes.

To set the sleep timer using the on-screen menus:

- 1 Press **MENU** and open the **Setup** menu.
- 2 Highlight **Sleep Timer** and press **ENTER**.

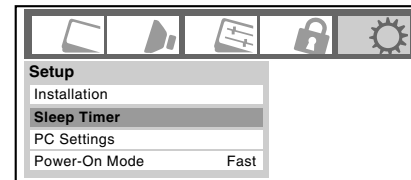

- 3 Press the Number buttons to enter the length of time in 10-minute increments.

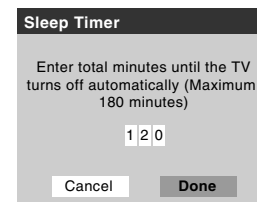

- 4 Highlight **Done** and press **ENTER**.

Note: When a power failure occurs, the sleep timer setting may be cleared.

To display the remaining sleep time:

Press **SLEEP**.

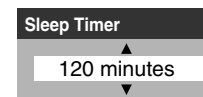

Note: A message will display on-screen when there is one minute remaining on the sleep timer.

To cancel the sleep timer:

Repeatedly press **SLEEP** until it is set to 0 minute.

Chapter 6: Using the TV's features

Displaying TV status information

To display TV status information using RECALL:

Press **RECALL** on the remote control.

The following information will display (if applicable):

- Current input (**ANT**, **VIDEO 1**, etc.)
- If ANT is the current input, either "CABLE" (for cable TV) or "ANT" (for over-the-air broadcasts).
- Channel number (if in **ANT** mode)
- Channel label (if set)
- Digital signal strength indicator (bar graph in lower right corner of box; for ATSC signal only)
- Stereo, Mono or SAP audio status (when HDMI input mode, Dolby Digital or PCM)
- Video resolution
- Aspect ratio of incoming video signal (4:3 or 16:9)
- V-Chip rating status
- Lamp Mode (☀: High Bright)



To close the RECALL screen:

Press **RECALL** again.

To display TV status information using INFO:

Press **INFO** on the remote control.

The following additional information will display for off air digital channels (if applicable):

- Title
- Duration
- Detailed description



Note: The location of the banner can be moved to the top or bottom of the screen by pressing **▲** or **▼** while the **RECALL** or **INFO** display is on-screen. (The last position will be stored to memory.)

Understanding the auto power off feature

The TV will automatically turn itself off after approximately 15 minutes if it is tuned to a vacant channel or a station that completes its broadcast for the day. This feature functions in **ANT** mode only.

Understanding the last mode memory feature

If the power is cut off while you are viewing the TV, the Last Mode Memory feature automatically turns on the TV when the power is resupplied.

Note: You should unplug the TV's power cord if it is possible that you will be away from the TV for an extended period of time after the power is restored.

Chapter 7: Using the TV's advanced features

Using the advanced picture settings features

Using dynamic contrast

When dynamic contrast is set to **Low**, **Middle**, or **High**, the TV will detect changes in the picture quality that affect the appearance of your contrast settings and then automatically adjust the video.

To select dynamic contrast preferences:

- 1 Press **MENU** and open the **Video** menu.
- 2 Highlight **Picture Settings** and press **ENTER**.

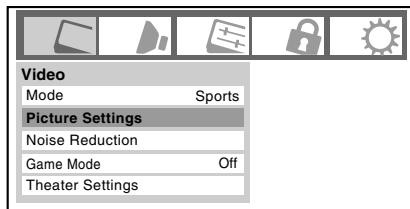

- 3 Highlight **Advanced Picture Settings** and press **ENTER**.

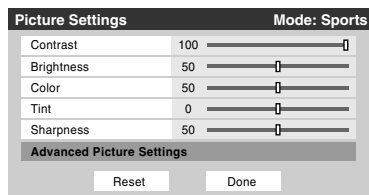

- 4 In the **Dynamic Contrast** field, select either **Off**, **Low**, **Middle** or **High**.

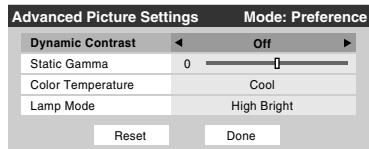

- 5 To save the new settings, highlight **Done** and press **ENTER**. To revert to the factory defaults, highlight **Reset** and press **ENTER**.

Note: If you select one of the factory-set picture modes (**Sports**, **Standard**, or **Movie**) and then change the dynamic contrast setting, the picture mode automatically changes to **Preference**.

Using the static gamma feature

The static gamma feature allows you to adjust the levels of black in the picture.

To adjust the static gamma settings:

- 1 Press **MENU** and open the **Video** menu.
- 2 Highlight **Picture Settings** and press **ENTER**.

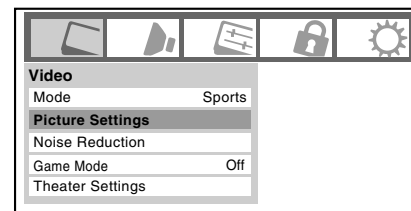

- 3 Highlight **Advanced Picture Settings** and press **ENTER**.

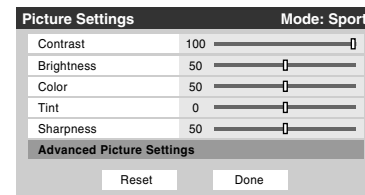

- 4 In the **Static Gamma** field, press **◀** or **▶** to adjust the static gamma.

The adjustment range is within ± 5 from center.

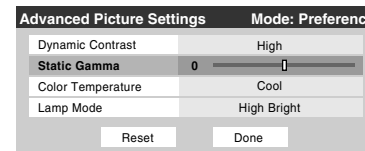

- If the setting is moved in the minus direction, the detail of black colors will be decreased.
- If the setting is moved in the plus direction, the detail of black colors will be increased.

- 5 To save the new settings, highlight **Done** and press **ENTER**. To revert the factory defaults, highlight **Reset** and press **ENTER**.

Note: If you select one of the factory-set picture modes (**Sports**, **Standard** or **Movie**) and then change the static gamma setting, the picture mode automatically changes to **Preference**.

Chapter 7: Using the TV's advanced features

Selecting the color temperature

You can change the quality of the picture by selecting from three preset color temperatures (Cool, Medium, and Warm), as described below.

Mode	Picture Quality
Cool	blueish
Medium	neutral
Warm	reddish

To select the color temperature:

- 1 Press **MENU** and open the **Video** menu.
- 2 Highlight **Picture Settings** and press **ENTER**.
- 3 Highlight **Advanced Picture Settings** and press **ENTER**.
- 4 In the **Color Temperature** field, select the mode you prefer (**Cool**, **Medium**, or **Warm**).

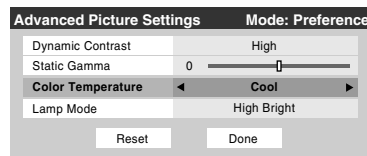

- 5 To save the new settings, highlight **Done** and press **ENTER**. To revert to the factory defaults, highlight **Reset** and press **ENTER**.

Note: If you select one of the factory-set picture modes (**Sports**, **Standard**, or **Movie**) and then change the color temperature mode, the picture mode automatically changes to **Preference**.

Selecting the lamp mode

You can select either the **High Bright** or **Low Power** lamp mode.

The **High Bright** mode is useful when additional picture brightness is desired (such as in a bright room).

Note: The **Lamp Mode** field will be grayed out for a while after the TV is turned on.

To select the lamp mode:

- 1 Press **MENU** and open the **Video** menu.
- 2 Highlight **Picture Settings** and press **ENTER**.
- 3 Highlight **Advanced Picture Settings** and press **ENTER**.
- 4 In the **Lamp Mode** field, select either **High Bright** or **Low Power**.

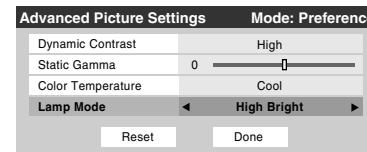

- 5 To save the new settings, highlight **Done** and press **ENTER**. To revert to the factory defaults, highlight **Reset** and press **ENTER**.

Note: If you set the lamp mode to **Low Power**, each time you turn on the TV, the lamp will start out in **High Bright** mode but will switch to **Low Power** mode after a short period of time. You may notice a change in screen brightness when this happens. This is normal and is not a sign of malfunction.

Chapter 7: Using the TV's advanced features

Using CableClear® digital noise reduction

The CableClear® digital noise reduction feature allows you to reduce visible interference in your TV picture. This may be useful when receiving a broadcast with a weak signal (especially a Cable channel) or playing a noisy video cassette or disc.

To change the CableClear settings:

- 1 Press **MENU** and open the **Video** menu.
- 2 Highlight **Noise Reduction** and press **ENTER**.

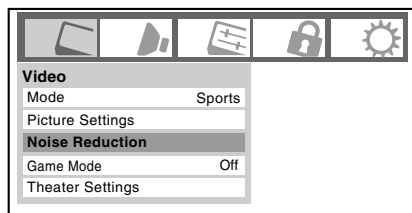

- 3 In the **CableClear** field, select your desired setting.

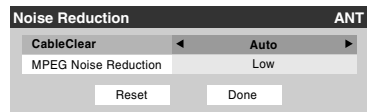

Note:

- If the current input is **ANT**, **VIDEO 1**, or **VIDEO 2**, the menu will display the text "CableClear." The available selections are **Off**, **Auto**, **Low**, **Middle**, and **High**.
 - If the current input is **ColorStream HD1**, **ColorStream HD2**, **HDMI 1**, **HDMI 2**, or **HDMI 3** the menu will display the text "DNR." The available selections are **Off**, **Auto**, **Low**, **Middle**, and **High**. **Auto** will react proportionally to the strength of the noise. **Low**, **Middle**, and **High** will reduce the noise in varying degrees, from lowest to highest, respectively.
- 4 To save the new settings, highlight **Done** and press **ENTER**. To revert to the factory defaults, highlight **Reset** and press **ENTER**.

Using MPEG noise reduction

The MPEG noise reduction feature allows you to reduce visible interference caused by MPEG compression. Choices for MPEG noise reduction are **Off**, **Low**, **Middle**, and **High**. **Off** is automatically selected when this feature is disabled ("grayed out").

To select the MPEG noise reduction level:

- 1 Press **MENU** and open the **Video** menu.
- 2 Highlight **Noise Reduction** and press **ENTER**.
- 3 Press **▲** or **▼** to highlight the **MPEG Noise Reduction** field, and then press **◀** or **▶** to select either **Off**, **Low**, **Middle** or **High**.

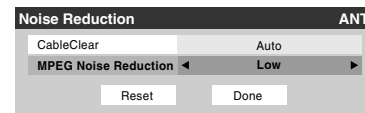

- 4 To save the new settings, highlight **Done** and press **ENTER**. To revert to the factory defaults, highlight **Reset** and press **ENTER**.

Chapter 7: Using the TV's advanced features

Using the Game Mode feature

You can use the Game Mode feature for shorter frame delays when playing a video game requiring split-second timing between the on-screen display and input from the controller (such as music creation and high-action games).

This feature is more effective for 480i and 1080i input signals.

Note: To use the Game Mode feature, the current video input must be **Video 1**, **Video 2**, **ColorStream HD1**, **ColorStream HD2**, **HDMI 1**, **HDMI 2**, or **HDMI 3**. The Game Mode cannot be turned on when any other video input is selected.

To turn on Game Mode:

- 1 Press **MENU** and open the **Video** menu.
- 2 Press **▲** or **▼** to highlight the **Game Mode** field, and then press **◀** or **▶** to select **On**.

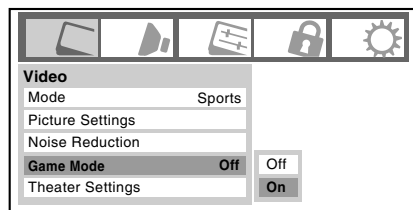

To turn off Game Mode:

Select **Off** in step 2 above, change the video input, or turn the TV off and then on again.

Note: You can change the video input by pressing **INPUT** on the remote control (see page 37).

Using the advanced audio settings features

Using the SRS WOW™ surround sound feature

SRS WOW™ is a special combination of SRS Labs audio technologies (SRS 3D, SRS Focus, and SRS TruBass) that creates a thrilling surround sound experience with deep, rich bass from stereo sound sources. Your TV's audio will sound fuller, richer, and wider.

To adjust the WOW™ settings:

- 1 Put the TV in **STEREO** mode (see "Selecting stereo/SAP broadcasts" on page 47).
- 2 Press **MENU** and open the **Audio** menu.
- 3 Highlight **Advanced Audio Settings** and press **ENTER**.
- 4 Press **▼** or **▲** to highlight the WOW feature you want to adjust, and then press **◀** or **▶** to adjust the item.

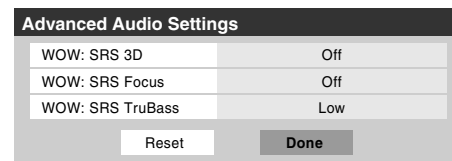

- **WOW: SRS 3D** — To turn the surround sound effect **On** or **Off**.
Note: If the broadcast is monaural, the SRS 3D effect will not work.
 - **WOW: SRS Focus** — To turn the vocal emphasis effect **On** or **Off**.
 - **WOW: SRS TruBass** — To select the desired bass expansion level (**Off**, **Low**, or **High**).
- 5 To save the new settings, highlight **Done** and press **ENTER**. To revert to the factory defaults, highlight **Reset** and press **ENTER**.

WOW, SRS and **●** symbol are trademarks of SRS Labs, Inc. WOW technology is incorporated under license from SRS Labs, Inc.

Chapter 8: Troubleshooting

General troubleshooting

Before calling a service technician, please check this chapter for a possible cause of the problem and some solutions you can try.

Black box on-screen

- The closed caption feature is set to one of the Text modes (**T1**, **T2**, **T3**, or **T4**). Set the closed caption feature to **Off** (ⓘ page 45).

TV stops responding to controls

- If the TV stops responding to the controls on the remote control or TV control panel and you cannot turn off the TV, press and hold the **POWER** button on the TV control panel for 5 or more seconds to reset the TV.

Other problems

- If your TV's problem is not addressed in this Troubleshooting section or the recommended solution has not worked, use the Restore Factory Defaults procedure (ⓘ page 36).

TV will not turn on

- Make sure the power cord is plugged in, and then press **POWER**.
- The remote control batteries may be dead. Replace the batteries or try the control panel buttons.
- If you have recently replaced the lamp unit, make sure the lamp unit and lamp unit door are installed properly (ⓘ pages 63–65).
- The lamp unit may need to be replaced (ⓘ pages 63–65). Also see “LED indications” (ⓘ page 62).
- If the TV is powered off and then quickly on again when the lamp unit is hot, it may take several minutes for the picture to appear on-screen. This is a property of DLP® TV lamp technology and is NOT a sign of malfunction. For details, see “IMPORTANT NOTICE ABOUT HOT LAMP RESTART” (ⓘ page 6).

Picture problems

General picture problems

- Check the antenna/cable connections (ⓘ Chapter 2).
- Press **(INPUT)** on the remote control or TV and select a valid video input source (ⓘ page 37). If no device is connected to a particular input on the TV, no picture will display when you select that particular input source. For device connection details, see Chapter 2.
- Antenna reception may be poor. Use a highly directional outdoor antenna (if applicable).
- The station may have broadcast difficulties. Try another channel.
- Adjust the picture qualities (ⓘ page 44).
- If you are using a VCR, make sure **TV/VCR** on the remote control is set correctly (ⓘ page 24).
- Do not connect both a standard video cable and an S-video cable to the **VIDEO 2** input at the same time (ⓘ page 15).

Noisy picture

- If you are watching an analog channel (off-air broadcast or Cable TV), you can set the **CableClear®/DNR** feature to **AUTO** to reduce visible interference in the TV picture (ⓘ page 58).

Video Input Selection problems

- If the **Input Selection** window does not appear when you press **(INPUT)** on the remote control or TV, press **(INPUT)** a second time, which will change to the next video input source and display the **Input Selection** window.

Cannot view external signals or channel 3 or 4

- If you cannot view signals from external devices connected to **VIDEO 1**, **VIDEO 2**, **ColorStream®**, **HDMI 1**, **HDMI 2**, **HDMI 3**, **PC**, or from channels 3 or 4, make sure the **Input Lock** is set to **Off** (ⓘ page 52).

Poor color or no color

- The station may have broadcast difficulties. Try another channel.
- Adjust the **Tint** and/or **Color** (ⓘ page 44).

Picture brightness changes soon after turning on TV

- If you set the lamp mode to **Low Power**, each time you turn on the TV, the lamp will start out in **High Bright** mode but will switch to **Low Power** mode after a short period of time. You may notice a change in screen brightness when this happens. This is normal and is not a sign of malfunction (ⓘ page 57).

Poor composite or S-video picture

- If the TV is connected to an external A/V device (e.g., DVD player, video game system, set-top box, etc.) try using a **ColorStream** or **HDMI** video connection instead.

Picture and sound are out of sync

- As with all products that contain a digital display, in rare instances, when viewing certain content (e.g., television broadcasts, video games, DVDs), you may notice that the sound and picture are slightly out of sync. This phenomenon can be caused by various factors including, without limitation, video processing within the TV, video processing in an attached gaming system, and video processing or different compression rates used by broadcasters in their programming. You may want to try one or more of the following suggestions, which may help to reduce the effect of this phenomenon:
 - If the TV is connected to an A/V receiver that has a programmable audio delay feature, use this feature to help synchronize the sound to the picture.
 - If you notice this phenomenon only on certain TV channels, please contact your local broadcast, cable, or satellite provider to inform them of this issue.

LED indications while in reboot from standby

- When you plug the power cord in, the yellow LED will blink until the TV enters standby mode, (plugged in but not powered on). This is normal and is not a sign of malfunction.

Sound problems

- Check the antenna/cable connections (ⓘ Chapter 2).
- The station may have broadcast difficulties. Try another channel.

Chapter 8: Troubleshooting

- The sound may be muted. Press **VOLUME**.
- If you hear no sound, try setting the **MTS** feature to **Stereo** mode (ⓘ page 47).
- If you are not receiving a second audio program from a known SAP source, make sure the **MTS** feature is set to **SAP** mode (ⓘ page 47).
- If you hear audio that seems “incorrect” for the program you are watching (such as music or a foreign language), the SAP mode may be on. Set the **MTS** feature to **Stereo** mode (ⓘ page 47).
- When using an external audio amplifier, if you connect the amplifier to the **FIXED AUDIO OUT** terminals, the volume of the amplifier must be set above 0 or you will not hear any sound (ⓘ page 20).

Remote control problems

- Make sure the remote control is set to the correct device mode (ⓘ page 23).
- Remove all obstructions between the remote control and the TV.
- The remote control batteries may be dead. Replace the batteries (ⓘ page 22).
- Your TV remote control may not operate certain features on your external device. Refer to the owner’s manual for your other device to determine its available features. If your TV remote control does not operate a specific feature on another device, use the remote control that came with the device (ⓘ pages 24–28).
- If the TV still does not act as expected, use the Reset Factory Defaults procedure (ⓘ page 36).

Channel tuning problems

- Make sure the remote control is set to the correct device mode (ⓘ page 23).
- The channel may have been erased from the channel memory by the **Channel Add/Delete** feature. Add the channel to the channel memory (ⓘ page 32).
- The channel may be blocked by the **Channels Block** feature. Unblock the channel (ⓘ page 51).
- If you are unable to tune digital channels, check the antenna configuration (ⓘ page 31). If you are still unable to tune digital channels, clear all channels from the channel list (ⓘ page 33) and reprogram channels into the channel memory (ⓘ page 32). If you are still unable to tune digital channels, use the Reset Factory Defaults procedure (ⓘ page 36). Also see “TV stops responding to controls” and “Other problems” (ⓘ page 60).

Closed caption problems

- If the program or video you selected is not closed-captioned, no captions will display (ⓘ page 45).
- If text is not available, a black rectangle may appear. If this happens, turn off the closed caption feature (ⓘ page 45).
- A closed-caption signal may not display correctly in the following situations: a) when a videotape has been dubbed; b) when the signal reception is weak; or c) when the signal reception is nonstandard (ⓘ page 45).

Rating blocking (V-Chip) problems

- If you forget your PIN code: While the PIN code entering screen is displayed, press **RECALL** four times within 5 seconds. The PIN code you previously stored will be cleared (ⓘ page 49).
- The V-Chip feature is available for the U.S. V-Chip system only (ⓘ page 50).

Chapter 8: Troubleshooting

LED indications

The yellow, blue, and red/green LED lights on the TV (at the bottom center of the TV) indicate the TV's status, as described below.

Note: If the TV loses A/C power (e.g., a power outage occurs or the power cord is unplugged), when power is restored, the yellow LED will blink while the TV is booting until the remote control is usable. This is normal and is not a sign of malfunction.

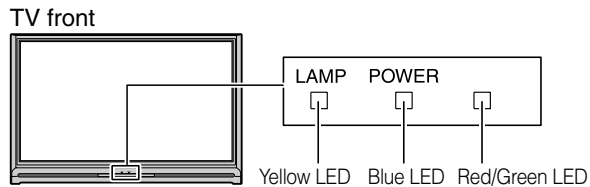

“Voice announce” feature

When certain non-standard conditions occur, the LEDs on the TV will blink and the TV will play a recorded “voice announcement” describing the condition (see the table below for the specific conditions that include a voice announcement). To repeat the voice announcement and hear additional information, press the MENU button on the TV while the LEDs are blinking.

LED Indication	Condition	Solution	Voice Announce
1) Blue is ON (solid).	The TV is operating properly.	–	–
2) Green is ON (solid).	Power-On Mode Fast.	See “Setting the Power-On Mode feature” (page 35).	–
3) Yellow blinks.	Standby with Power-On Mode Fast.		
4) Blue is ON (solid). Yellow blinks.	The lamp is not working properly.	The TV will automatically try to restart itself eight times (see item #5). Note: If the TV is powered off and then quickly on again when the lamp unit is hot, it may take several minutes for the picture to appear on-screen. This is a property of DLP® TV lamp technology and is NOT a sign of malfunction. For details, see “Setting the Power-On Mode feature” and “IMPORTANT NOTICE ABOUT HOT LAMP RESTART” (page 35).	–
5) Yellow is ON (solid). Red blinks.	The lamp is not working properly after the eighth automatic restart (see item #3).	Turn the TV OFF and then ON again. If the problem persists, contact TACP Consumer Solutions at 1-800-631-3811 in the U.S. or TCL Customer Service at 1-800-268-3404 in Canada.	“Lamp not working”
6) Yellow is ON (solid).	The lamp unit door is not seated properly.	Turn OFF the TV and unplug the power cord. Review “Lamp unit replacement and care” in Chapter 9 to ensure that the lamp door is installed securely.	“Lamp door is open.”
7) Red blinks.	Fan stopped.	Turn OFF the TV and unplug the power cord. Plug the power cord in again and turn ON the TV.	“Fan stopped.”
8) Blue blinks slowly. Red blinks.	Abnormal operation of BUS line. (light engine).		–
9) Blue blinks slowly.	Abnormal operation of BUS line.		–
10) Blue blinks quickly.	Power Protect Detection.		–
11) Blue blinks quickly. Red blinks.	The color wheel has stopped.		“Color wheel stopped.”
12) Blue blinks quickly. Yellow blinks. Red blinks.	An abnormal temperature increase has occurred.	Turn OFF the TV. Check to make sure none of the slots or openings in the TV cabinet are covered, blocked, or dusty. Turn ON the TV again.	“Temperature warning.”

If, after trying the solution, the problem still exists:

- In the U.S., call TACP Consumer Solutions at 1-800-631-3811.
- In Canada, locate the nearest Toshiba authorized service depot by directing your web browser to www.toshiba.ca; click “Home Entertainment,” and then click “Support.”

Chapter 9: Appendix

Lamp unit replacement and care

Replacing the lamp unit (User-replaceable component)



WARNING: RISK OF ELECTRIC SHOCK!



TO REDUCE THE RISK OF ELECTRIC SHOCK, NEVER REMOVE TV COVERS, EXCEPT AS SPECIFIED HEREIN. REFER ALL SERVICING NOT SPECIFIED IN THIS MANUAL TO QUALIFIED SERVICE PERSONNEL. Failure to follow this WARNING may result in death or serious injury.

The light source for this TV is a mercury lamp with internal atmospheric pressure that increases during use. The lamp has a limited service life that varies depending on product use and user settings.

As is generally the case with all projection TVs that use projection lamps as a light source, the brightness of the lamp in this TV may vary somewhat over the expected service life and will generally decrease over time. Because of the many variables that can affect the useful service life of the lamp, your experience may vary from other users.

Note : *The lamp is warranted only for the periods and to the extent set forth in the Limited Warranty applicable to this set. See "Limited United States Warranty" (page 67) or "Limited Canadian Warranty" (page 68), as applicable.*

If you use the lamp beyond its service life:

- you may notice a reduction in the colors and/or brightness of the picture; and
- the strength of the quartz glass in the lamp will be reduced and the lamp may rupture (often making a loud noise when this happens). If the lamp ruptures, the TV will not operate until the lamp unit is replaced.



CAUTION: Always handle the lamp unit with care.

The lamp unit in this TV was designed for safe replacement by consumers; however, if the lamp unit is subjected to intentional abuse (such as excessive mechanical abuse or handling by children or pets), the unit may break, exposing sharp edges or pinch points.

When to replace the lamp unit

You should replace the lamp unit:

- if the picture darkens and/or colors fade;
- if the screen (lamp) does not light (**LED indication #4**, page 62); or
- if you hear a loud noise and the picture goes black, which may indicate a lamp rupture (**LED indication #4**, page 62).

To obtain a replacement lamp unit:

In the U.S.

In warranty: Visit www.tacp.toshiba.com/service or call toll-free 1-800-631-3811.

Out of warranty: Visit www.ceaccessories.toshiba.com or consult your consumer electronics dealer.

In Canada

Locate a Toshiba parts distributor by visiting www.toshiba.ca. Click "Home Entertainment" and then click "Support."

Always replace the lamp unit with the model currently recommended by Toshiba.

For more information, please contact us at the telephone numbers or websites listed above, as applicable.

Using any lamp other than those recommended by Toshiba may cause damage to the TV and/or lamp. SUCH DAMAGE IS NOT COVERED UNDER YOUR TOSHIBA WARRANTY.

Chapter 9: Appendix

How to replace the lamp unit



WARNING: RISK OF ELECTRIC SHOCK!



TO REDUCE THE RISK OF ELECTRIC SHOCK, NEVER REMOVE TV COVERS, EXCEPT AS SPECIFIED HEREIN. REFER ALL SERVICING NOT SPECIFIED IN THIS MANUAL TO QUALIFIED SERVICE PERSONNEL. Failure to follow this WARNING may result in death or serious injury.

Required tools:

- Manual screwdrivers (Phillips and slotted)
- Soft, lint-free gloves

- 1 Turn off the TV and unplug the power cord.



WARNING: Eye damage may result from directly viewing the light produced by this lamp.

Always turn off the TV and unplug the power cord before opening the lamp unit door.

- 2 **STOP!** Allow the lamp to cool for at least one (1) hour before replacing it.



CAUTION: HOT SURFACE!



Touching the lamp before it has cooled will result in severe burns. ALLOW THE LAMP TO COOL FOR AT LEAST ONE (1) HOUR BEFORE REPLACING IT.

- 3 On the lamp unit door on the back of the TV, loosen the screw using a manual screwdriver, and then remove the lamp unit door.

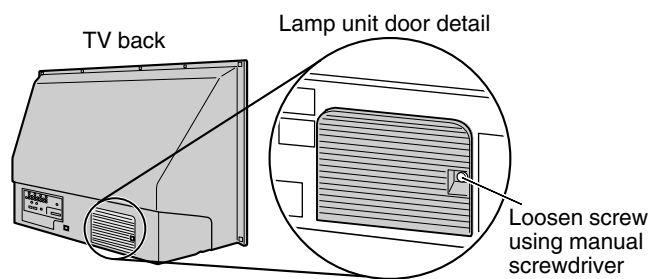

- 4 Using a manual Phillips screwdriver, loosen the two screws on the lamp unit.

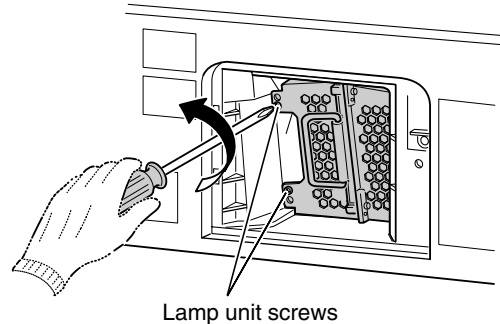

WARNING: RISK OF ELECTRIC SHOCK!



The lamp unit door is provided with an interlock to reduce the risk of electric shock and excessive ultraviolet radiation. **Never defeat its purpose or attempt to service without removing the lamp unit door completely.** Failure to follow this WARNING may result in death or serious injury.

- 5 Grasp the lamp unit handle and gently pull the lamp unit straight out of the TV. Set the old lamp unit aside (see "Disposing of the used lamp unit" on page 65).

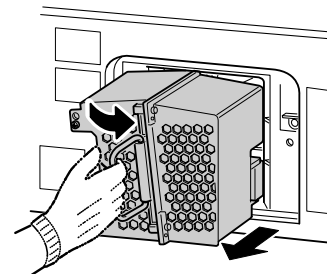

NOTE: Wear soft, lint-free gloves when replacing the lamp unit.

- 6 Carefully insert the new lamp unit straight into the TV until it is fully seated.

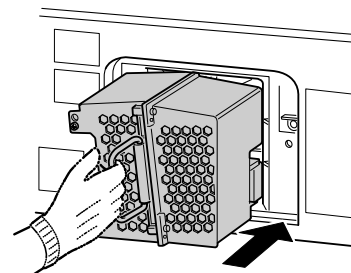

Chapter 9: Appendix

Note:

- Never subject the lamp unit to excessive shock.
- Never touch the lamp unit glass or otherwise get it dirty. Doing so may affect the image quality and reduce the service life of the lamp. See "Cleaning the lamp unit glass" below.

CLEANING THE LAMP UNIT GLASS

If you accidentally touch the lamp unit glass or otherwise get it dirty, wipe it with a lint-free lens cleaning cloth (such as a cloth for cleaning camera lenses or eyeglasses).



CAUTION: NEVER clean a hot lamp with any type of flammable liquid or aerosol cleaning agent.

Many ordinary cleaning agents (such as glass cleaners) contain chemicals that may be flammable at certain temperatures. If the lamp unit is not allowed to cool for at least one (1) hour, such chemicals may ignite.

- 7** Using a manual Phillips screwdriver, tighten the two lamp unit screws.

Note: Hand-tighten only. Do not use an electric screwdriver.

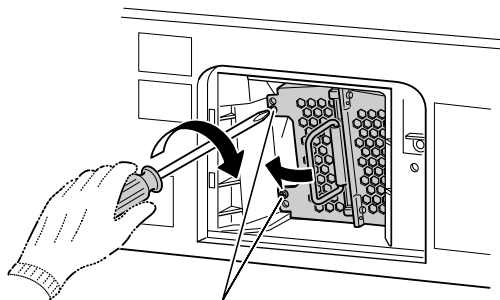

Lamp unit screws
(use manual Phillips screwdriver only)



NOTE : Make sure the lamp unit and screws are installed securely; otherwise, the TV may not turn on and the lamp life may be shortened.

- 8** Reattach the lamp unit door, making sure to insert the hooks on the left side of the lamp unit door inside the opening in the TV cabinet.

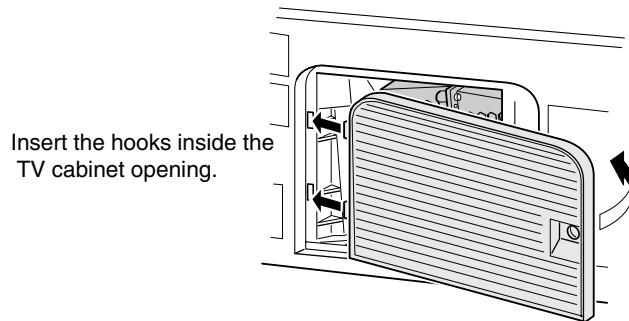

Insert the hooks inside the TV cabinet opening.

Lamp unit door

- 9** Replace the screw and tighten using a manual screwdriver.

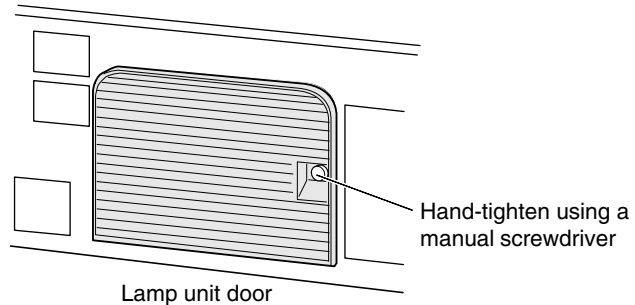

NOTE: Make sure the lamp unit door is installed securely; otherwise, the TV may not turn on.

- 10** Plug in the power cord and turn on the TV. After the initial warmup period (which may take several seconds for full picture brightness), the TV should operate normally. If any of the following conditions exist, turn off the TV, unplug the power cord, and repeat steps 1–9 to ensure that the lamp unit and lamp unit door are installed correctly:

- No picture
- Dark picture
- TV will not turn on

If, after repeating steps 1–9, the problem still exists:

- In the U.S., call TACP Consumer Solutions at 1-800-631-3811.
- In Canada, locate the nearest Toshiba authorized service depot by directing your web browser to www.toshiba.ca; click "Home Entertainment," and then click "Support."

Disposing of the used lamp unit

- Place the used lamp unit in the empty box from the new unit.
- Keep the lamp unit out of reach of children and pets.



CAUTION: Always handle the lamp unit with care.

The lamp unit in this TV was designed for safe replacement by consumers; however, if the lamp unit is subjected to intentional or accidental abuse (such as excessive mechanical abuse or handling by children or pets), the unit may break, exposing sharp edges or pinch points.

- Dispose of the used lamp unit by the approved method for your area.



NOTE: The lamp unit contains mercury. Disposal of mercury may be regulated due to environmental considerations. For disposal or recycling information, contact your local authorities or the Electronic Industries Alliance (www.eiae.org).

Chapter 9: Appendix

Specifications

Note:

- **This model complies with the specifications listed below.**
- **Designs and specifications are subject to change without notice.**
- **This model may not be compatible with features and/or specifications that may be added in the future.**

Television System

NTSC standard
 ATSC standard (8VSB)
 Digital Cable (64 QAM, 256 QAM; in-the-clear, unencrypted)

Channel Coverage

VHF: 2 through 13
 UHF: 14 through 69
 Cable TV: Mid band (A-8 through A-1, A through I)
 Super band (J through W)
 Hyper band (AA through ZZ, AAA, BBB)
 Ultra band (65 through 94, 100 through 135)

Power Source

120 V AC, 60 Hz

Power Consumption

57/65HM117: 205 W (average)
 Less than 1 W in standby POWER-SAVING MODE
 15 W in standby POWER-FAST MODE

Audio Power

10 W + 10 W

Speaker Type

Main: Two 2-3/8 × 4-3/4 inches (60 × 120 mm) round
 Tweeter: Two 1-5/16 inches (33 mm) round

Video/Audio Terminals

S-VIDEO INPUT:

Y: 1 V(p-p), 75 ohm, negative sync.
 C: 0.286 V(p-p) (burst signal), 75 ohm

VIDEO/AUDIO INPUT:

VIDEO: 1 V(p-p), 75 ohm, negative sync.
 AUDIO: 150 mV(rms) (30% modulation equivalent, 22 k ohm or greater)

ColorStream® (component video) HD INPUT:

VIDEO: Y: 1V(p-p), 75 ohm
 Pr: 0.7 V(p-p), 75 ohm
 Pb: 0.7 V(p-p), 75 ohm
 Suggested formats: 1080i, 720p, 480p, 480i
 AUDIO: 150 mV(rms), 22 k ohm or greater

HDMI™ INPUT:

HDMI compliant (type A connector)
 HDCP compliant

E-EDID* compliant

Suggested formats: 1080p (24/60Hz), 1080i (60Hz),
 720p (60Hz), 480p (60Hz), 480i (60Hz), VGA
 HDMI Audio: 2-channel L-PCM; 32/44.1/48 kHz
 sampling frequency; 16/20/24 bits per sample

FIXED AUDIO OUTPUT:

150 mv (rms) (30% modulation equivalent, 2.2 k ohm or less)

DIGITAL AUDIO OUTPUT:

Optical type

IR OUT:

3 V(p-p), 3.5 mm mono socket

PC INPUT:

15-Pin D-sub Analog RGB

Pin No.	Signal name	Pin No.	Signal name
1	R	9	NC
2	G	10	Ground
3	B	11	NC
4	NC (Not connected)	12	NC
5	NC	13	H-sync
6	Ground	14	V-sync
7	Ground	15	NC
8	Ground		

Dimensions

57HM117: Width: 52-3/8 inches (1,331 mm)
 Height: 33-3/4 inches (857 mm)
 Depth: 18-3/4 inches (476 mm)
 65HM117: Width: 58 inches (1,473 mm)
 Height: 37-1/8 inches (942 mm)
 Depth: 21-11/16 inches (550 mm)

Mass (weight)

57HM117: 72.0 lbs (32.6 kg)
 65HM117: 83.0 lbs (37.6 kg)

Operating conditions

Temperature: 41°F - 95°F (5°C - 35°C)
 Humidity: 20 - 80% (no moisture condensation)

Supplied Accessories

- Remote control with two size “AAA” batteries
 - Owner’s manual (this book)
 - TV stand
- 57HM117 (VF0A0000280)
 65HM117 (VF0A0000270)

* E-EDID = Enhanced-Extended Display Identification

Chapter 9: Appendix

Limited United States Warranty

for DLP® Television Models

Toshiba America Consumer Products, L.L.C. ("TACP") makes the following limited warranties to original consumers in the United States.

THESE LIMITED WARRANTIES EXTEND TO THE ORIGINAL CONSUMER PURCHASER OR ANY PERSON RECEIVING THIS DLP® TELEVISION AS A GIFT FROM THE ORIGINAL CONSUMER PURCHASER AND TO NO OTHER PURCHASER OR TRANSFEREE.

DLP® TELEVISIONS PURCHASED IN THE U.S.A. AND USED ANYWHERE OUTSIDE OF THE U.S.A., INCLUDING, WITHOUT LIMITATION, CANADA AND MEXICO, ARE NOT COVERED BY THESE WARRANTIES.

DLP® TELEVISIONS PURCHASED ANYWHERE OUTSIDE OF THE U.S.A., INCLUDING, WITHOUT LIMITATION, CANADA AND MEXICO, AND USED IN THE U.S.A., ARE NOT COVERED BY THESE WARRANTIES.

Limited One (1) Year Warranty on Parts and Labor

TACP warrants this DLP® Television and its parts against defects in materials or workmanship for a period of one (1) year after the date of original retail purchase. **DURING THIS PERIOD, TACP WILL, AT TACP'S OPTION, REPAIR OR REPLACE A DEFECTIVE PART WITH A NEW OR REFURBISHED PART WITHOUT CHARGE TO YOU FOR PARTS OR LABOR.** During this period, TACP Authorized Service Station personnel will come to your home when warranty service is required. Depending on the type of repair required, the service will either be performed in your home or the DLP® Television will be taken to a TACP Authorized Service Station for repair and returned to your home at no cost to you.

Limited One (1) Year Warranty on Lamp Unit

TACP warrants the original lamp unit contained in this DLP® Television against defects in materials or workmanship for a period of one (1) year after the date of original retail purchase. **DURING THIS PERIOD, TACP WILL, AT TACP'S OPTION, EXCHANGE A DEFECTIVE LAMP UNIT WITH A NEW OR REFURBISHED LAMP UNIT WITHOUT CHARGE TO YOU. LABOR CHARGES FOR LAMP UNIT REPLACEMENT ARE YOUR RESPONSIBILITY AND ARE NOT COVERED UNDER THIS WARRANTY.** The lamp unit is a user-replaceable component.

Rental Units

The warranty for DLP® Television rental units begins on the date of the first rental or thirty (30) days after the date of shipment to the rental firm, whichever comes first.

Limited Warranty for Commercial Units

TACP warrants DLP® Televisions, including the lamp units contained therein, that are sold and used for commercial purposes as follows: all parts are warranted against defects in materials or workmanship for a period of ninety (90) days after the date of original retail purchase. **DURING THIS PERIOD, TACP WILL, AT TACP'S OPTION, REPAIR OR REPLACE A DEFECTIVE PART WITH A NEW OR REFURBISHED PART WITHOUT CHARGE TO YOU.**

Owner's Manual and Product Registration Card

Read this owner's manual thoroughly before operating this DLP® Television.

Complete and mail the enclosed product registration card or register your DLP® Television online at www.tacp.toshiba.com/service as soon as possible. By registering your DLP® Television you will enable TACP to bring you new products specifically designed to meet your needs and help us to contact you in the unlikely event a safety notification is required under the U.S. Consumer Product Safety Act. Failure to complete and return the product registration card does not diminish your warranty rights.

Your Responsibility

THE ABOVE WARRANTIES ARE SUBJECT TO THE FOLLOWING CONDITIONS:

- (1) You must retain your original bill of sale or provide other proof of purchase.
- (2) All warranty servicing of this DLP® Television must be performed by an Authorized TACP Service Station.
- (3) The warranties from TACP are effective only if this DLP® Television is purchased and operated in the Continental U.S.A. or Puerto Rico.
- (4) Labor service charges for set installation, setup, adjustment of customer controls, and installation or repair of antenna systems are not covered by this warranty. Reception problems caused by inadequate antenna systems, misaligned satellite dishes, cable television distribution, VCRs, DVD players/recorders, personal computer level IEEE 1394 devices, and any other connected signal source device are your responsibility.
- (5) Warranties extend only to defects in materials or workmanship as limited above, and do not extend to any DLP® Television or parts that have been lost or discarded by you or to damage to the DLP® Television or parts caused by fires, misuse, accident, Acts of God (such as lightning or fluctuations in electric power), improper installation, improper maintenance, or use in violation of instructions furnished by TACP; use or malfunction through simultaneous use of this DLP® Television and connected equipment; or to units that have been modified or had the serial number removed, altered, defaced, or rendered illegible.

How to Obtain Warranty Service

If, after following all of the operating instructions in this manual and reviewing the section entitled "Troubleshooting," you find that service is needed:

- (1) To find the nearest TACP Authorized Service Station, visit TACP's website at www.tacp.toshiba.com/service or contact TACP's Consumer Solution Center toll free at 1-800-631-3811.
- (2) You must present your original bill of sale or other proof of purchase to the TACP Authorized Service Station.

**For additional information, visit TACP's website:
www.tacp.toshiba.com.**

ALL WARRANTIES IMPLIED BY THE LAW OF ANY STATE OF THE U.S.A., INCLUDING THE IMPLIED WARRANTIES OF MERCHANTABILITY AND FITNESS FOR A PARTICULAR PURPOSE, ARE EXPRESSLY LIMITED TO THE DURATION OF THE LIMITED WARRANTIES SET FORTH ABOVE. WITH THE EXCEPTION OF ANY WARRANTIES IMPLIED BY THE LAW OF ANY STATE OF THE U.S.A. AS HEREBY LIMITED, THE FOREGOING WARRANTY IS EXCLUSIVE AND IN LIEU OF ALL OTHER WARRANTIES, GUARANTEES, AGREEMENTS, AND SIMILAR OBLIGATIONS OF TACP WITH RESPECT TO THE REPAIR OR REPLACEMENT OF ANY PARTS. IN NO EVENT SHALL TACP BE LIABLE FOR CONSEQUENTIAL OR INCIDENTAL DAMAGES (INCLUDING, BUT NOT LIMITED TO, LOST PROFITS, BUSINESS INTERRUPTION, OR MODIFICATION OR ERASURE OF RECORDED DATA CAUSED BY USE, MISUSE OR INABILITY TO USE THIS DLP® TELEVISION).

No person, agent, distributor, dealer, or company is authorized to change, modify, or extend the terms of these warranties in any manner whatsoever. The time within which an action must be commenced to enforce any obligation of TACP arising under the warranty or under any statute or law of the United States or any state thereof is hereby limited to ninety (90) days from the date you discover, or should have discovered, the defect. This limitation does not apply to implied warranties arising under the law of any state of the U.S.A.

THIS WARRANTY GIVES YOU SPECIFIC LEGAL RIGHTS AND YOU MAY ALSO HAVE OTHER RIGHTS WHICH MAY VARY FROM STATE TO STATE IN THE U.S.A. SOME STATES OF THE U.S.A. DO NOT ALLOW LIMITATIONS ON THE DURATION OF AN IMPLIED WARRANTY, WHEN AN ACTION MAY BE BROUGHT, OR THE EXCLUSION OR LIMITATION OF INCIDENTAL OR CONSEQUENTIAL DAMAGES. THEREFORE, THE ABOVE PROVISIONS MAY NOT APPLY TO YOU UNDER SUCH CIRCUMSTANCES.

05

Chapter 9: Appendix

Limited Canadian Warranty

for Toshiba Brand DLP® Television Models

Toshiba of Canada Limited ("TCL") makes the following limited warranties to original consumers in Canada. THESE LIMITED WARRANTIES EXTEND TO THE ORIGINAL CONSUMER PURCHASER OR ANY PERSON RECEIVING THIS TOSHIBA BRAND DLP® TELEVISION MODEL (the "TELEVISION(S)" or "Television(s)") AS A GIFT FROM THE ORIGINAL CONSUMER PURCHASER AND TO NO OTHER PURCHASER OR TRANSFEREE.

TELEVISIONS PURCHASED IN CANADA, AND USED ANYWHERE OUTSIDE OF CANADA INCLUDING, WITHOUT LIMITATION, THE UNITED STATES AND MEXICO, ARE NOT COVERED BY THESE WARRANTIES.

TELEVISIONS PURCHASED ANYWHERE OUTSIDE OF CANADA, INCLUDING, WITHOUT LIMITATION, THE UNITED STATES AND MEXICO, AND USED IN CANADA, ARE NOT COVERED BY THESE WARRANTIES.

Limited One (1) Year Warranty on Parts and Labour

Subject to the more limited warranty if the Television is used for any commercial or business purposes as set out below, TCL warrants the Television and its parts, excluding the lamp unit, against material defects in materials or workmanship that result in the Television failing for a period of one (1) year after the date of original retail purchase. DURING THIS PERIOD, TCL WILL, AT TCL'S OPTION, REPAIR OR REPLACE A DEFECTIVE PART WITH A NEW OR REFURBISHED PART WITHOUT CHARGE TO YOU FOR PARTS OR LABOR. During this period, TCL Television authorized service provider ("ASP") personnel will come to your home when warranty service is required. Depending on the type of repair required, the service will either be performed in your home or the Television will be taken to an ASP for repair and returned to your home at no cost to you. IN-HOME SERVICE ONLY APPLIES WITHIN 100 KILOMETERS OF AN ASP. IF YOU ARE NOT WITHIN 100 KILOMETERS OF AN ASP, YOU MUST DELIVER THE ENTIRE TELEVISION TO AN ASP. YOU MUST PAY FOR ALL TRANSPORTATION AND INSURANCE CHARGES FOR THE TELEVISION TO AND FROM THE ASP.

Limited One (1) Year Warranty on the Lamp Unit

TCL warrants the lamp unit in this Television against material defects in materials or workmanship for a period of one (1) year after the date of original retail purchase. DURING THIS PERIOD, TCL WILL, AT TCL'S OPTION, REPAIR OR REPLACE THE DEFECTIVE LAMP UNIT WITH A NEW OR REFURBISHED LAMP UNIT WITHOUT CHARGE TO YOU FOR THE LAMP UNIT. YOU MUST DELIVER THE ENTIRE LAMP UNIT TO AN ASP. YOU MUST PAY FOR ALL TRANSPORTATION AND INSURANCE CHARGES FOR THE LAMP UNIT TO AND FROM THE ASP.

Limited Warranty for Commercial Units

TCL warrants Televisions that are used for any commercial or business purposes as follows: all parts are warranted against material defects in materials or workmanship that result in the Television failing for a period of ninety (90) days after the date of original retail purchase. DURING THIS PERIOD, TCL WILL, AT TCL'S OPTION, REPAIR OR REPLACE THE DEFECTIVE PART WITH A NEW OR REFURBISHED PART WITHOUT CHARGE TO YOU. ON-SITE SERVICE ONLY APPLIES WITHIN 100 KILOMETERS OF AN ASP. IF YOU ARE NOT WITHIN 100 KILOMETERS OF AN ASP, YOU MUST DELIVER THE ENTIRE TELEVISION TO AN ASP. YOU MUST PAY FOR ALL TRANSPORTATION AND INSURANCE CHARGES FOR THE TELEVISION TO AND FROM THE ASP.

Rental Units

The warranty for Television rental units begins with the date of first rental or thirty (30) days from the date of shipment to the rental firm, whichever comes first.

Your Responsibility

THE ABOVE WARRANTIES ARE SUBJECT TO THE FOLLOWING CONDITIONS:

- (1) You must provide your bill of sale or other proof of purchase.
- (2) All warranty servicing of this Television must be performed by an ASP.
- (3) The warranties from TCL are effective only if the Television is (i) purchased as new and unopened from TCL or from TCL's authorized distributors, dealers or resellers ("ADR's") and (ii) located/operated in Canada.
- (4) Labour charges for set installation, setup, adjustment of customer controls, and installation or repair of antenna systems are not covered by these warranties. Reception problems caused by inadequate antenna systems are your responsibility.
- (5) Warranties extend only to material defects in materials or workmanship as limited above, and do not extend to:
 - a) Service, repairs or replacement made necessary by accident, misuse, abuse, moisture, liquids, dust, dirt, neglect, accident, damage, 24/7 applications, improper installation, improper operation, improper cleaning, improper maintenance, normal wear and tear, or any other external cause or event, act or omission outside the control of TCL, including fire, theft, acts of God, alteration, power failures, power surges or power shortages, lightning, other electrical faults, or repairs, modifications or replacements by persons other than those authorized by TCL to service the Television;
 - b) Replacement of missing, discarded or lost parts, the provision of retrofits, or preventive maintenance;
 - c) Repair of damage that is cosmetic only or does not affect the Television functionality, such as wear and tear, scratches and dents;
 - d) Service on Toshiba-branded accessory items (such accessory items may be covered by their own warranty);
 - e) Service on third party products or service made necessary by use of incompatible third party products;
 - f) Service made necessary by the simultaneous use of this Television and connected equipment;
 - g) Modifications to the Television not approved in writing by TCL, and service made necessary by the use or installation of non-Toshiba modifications to the Television;
 - h) Service of a Television on which the TOSHIBA label or logo, rating label or serial number have been defaced or removed;
 - i) On-site service and repair of the Television; and
 - j) Damage to the Television caused by failure to follow the specifications, User manuals or guides as to usage and/or storage.

Disclaimer and Limitation of Remedy

TO THE EXTENT NOT PRECLUDED BY LAW, ALL OTHER EXPRESS AND IMPLIED WARRANTIES, CONDITIONS AND REPRESENTATIONS FOR THIS TELEVISION, INCLUDING THE IMPLIED WARRANTIES, CONDITIONS AND REPRESENTATIONS OF MERCHANTABILITY AND FITNESS FOR A PARTICULAR PURPOSE, ARE HEREBY DISCLAIMED AND EXCLUDED. IF THE APPLICABLE LAW, STATUTORY OR OTHERWISE, PRECLUDES THE EXCLUSION OF ANY IMPLIED WARRANTIES, CONDITIONS AND REPRESENTATIONS THEN SUCH IMPLIED WARRANTIES, CONDITIONS AND REPRESENTATIONS ARE OTHERWISE LIMITED IN DURATION TO THE TERM OF THIS EXPRESS WRITTEN LIMITED WARRANTY. TO THE EXTENT NOT PRECLUDED BY LAW, STATUTORY OR OTHERWISE, THIS WRITTEN WARRANTY SUPERCEDES AND SPECIFICALLY DISCLAIMS ANY OTHER WARRANTY, CONDITION OR REPRESENTATION NOT STATED IN THIS WARRANTY, WHETHER MADE BY TCL, TOSHIBA CORPORATION, THEIR AFFILIATES, ADRs AND ASPs AND WHETHER MADE ORALLY OR IN WRITING (INCLUDING ANY STATEMENT IN ANY BROCHURE, PRESS RELEASE, ANNOUNCEMENT, ADVERTISEMENT, POINT OF SALE DISPLAY, ETC.).

Chapter 9: Appendix

YOU MUST READ AND FOLLOW ALL SET-UP AND USAGE INSTRUCTIONS IN THE APPLICABLE USER GUIDES AND/OR MANUALS. IF YOU FAIL TO DO SO, THIS TELEVISION MAY NOT FUNCTION PROPERLY AND YOU MAY SUFFER DAMAGE. THIS WARRANTY WILL NOT COVER ANY SERVICE THAT IS REQUIRED, IN PART OR IN WHOLE, AS A RESULT OF ANY FAILURE TO FOLLOW THE SET-UP AND USAGE INSTRUCTIONS. THIS WARRANTY DOES NOT APPLY AND SHALL BE VOID AND UNENFORCEABLE IF THE TELEVISION IS OPENED, SERVICED, OR REPAIRED BY PERSONS OTHER THAN THOSE AUTHORIZED BY TCL TO SERVICE OR REPAIR THE TELEVISION.

IF THE TELEVISION FAILS TO WORK AS WARRANTED ABOVE, YOUR SOLE AND EXCLUSIVE REMEDY SHALL BE REPAIR OR REPLACEMENT OF THE DEFECTIVE PART. IN NO EVENT WILL TCL, TOSHIBA CORPORATION, THEIR AFFILIATES, ADRs OR ASPs (THE "**RELATED PARTIES**") BE LIABLE TO YOU OR ANY THIRD PARTY FOR ANY DAMAGES, MONEY, REIMBURSEMENT, COSTS OR EXPENSES. THIS LIMITATION APPLIES TO DAMAGES, MONEY, REIMBURSEMENT, COSTS OR EXPENSES OF ANY KIND WHATSOEVER INCLUDING ANY DIRECT OR INDIRECT DAMAGES, DAMAGE TO PROPERTY OR PERSON, LOST PROFITS, LOST SAVINGS, INCONVENIENCE OR OTHER SPECIAL, INCIDENTAL, EXEMPLARY OR CONSEQUENTIAL DAMAGES, WHETHER FOR BREACH OF WARRANTY, BREACH OF CONTRACT, TORT (INCLUDING NEGLIGENCE), UNDER A STATUTE OR UNDER ANY OTHER LAW OR FORM OR ACTION, OR WHETHER ARISING OUT OF THE USE OF OR INABILITY TO USE THE TELEVISION, EVEN IF ANY OF THE RELATED PARTIES HAS BEEN ADVISED OF THE POSSIBILITY OF SUCH DAMAGES OR OF ANY CLAIM BY ANY OTHER PARTY.

No person, agent, distributor, dealer or company is authorized to change, modify or extend the terms of these warranties in any manner whatsoever.

Arbitration and Dispute Resolution

To the extent not precluded by law, any claim, dispute, controversy or disagreement (whether for breach of warranty, breach of contract, tort (including negligence), under a statute or under any other law or form of action) against any of the Related Parties arising out of, or otherwise relating to: (i) this warranty; (ii) the Television; (iii) any oral or written representations, statements, brochures, press releases, advertising, announcement, point of sale display, or promotional material relating to the Television; (iv) the relationships that result from this warranty, (the foregoing claims, disputes controversies and disagreements are collectively referred to as the "Dispute"), shall be referred to and resolved by final and binding arbitration (to the exclusion of the courts). To the extent not precluded by law, you agree to waive any right that you may have to commence or participate in any representative or class proceeding against the Related Parties relating to any Dispute. If and where applicable and to the extent not precluded by law, you further agree to opt out of any such representative or class proceedings. Arbitration of any Dispute will be conducted in the forum and in the manner as agreed to between you and TCL. Failing such agreement, the arbitration will be conducted by one arbitrator pursuant to the laws and rules relating to arbitration generally in force in the jurisdiction in which you reside at the time that the Dispute arises. To the extent not precluded by law, no claim, dispute, controversy or disagreement of any other person may be joined or combined with any Dispute by you, without the prior written consent of TCL.

Critical Applications

The Television you have purchased is not designed for any "critical applications." "Critical applications" means life support systems, medical applications, connections to implanted medical devices, commercial transportation, nuclear facilities or systems or any other applications where Television failure could lead to injury to persons or loss of life or catastrophic property damage.

IF THE CUSTOMER USES THE TELEVISION IN ANY CRITICAL APPLICATION, THE CUSTOMER - AND NOT TCL, ITS AFFILIATES, ADRs OR ASPs - ASSUME SOLE AND FULL RESPONSIBILITY FOR SUCH USE. TCL RESERVES THE RIGHT TO REFUSE TO SERVICE ANY TELEVISION USED IN A CRITICAL APPLICATION. TCL, ITS AFFILIATES, ADRs AND ASPs HEREBY DISCLAIM ANY AND ALL LIABILITY, DAMAGES AND CONSEQUENCES ARISING OUT OF THE SERVICE OR REFUSAL TO SERVICE SUCH TELEVISION AND FURTHER DISCLAIM ANY AND ALL LIABILITY, CONSEQUENCES AND DAMAGES THAT MAY ARISE OR RESULT FROM THE USE OF THE TELEVISION IN ANY CRITICAL APPLICATIONS.

General Provisions

If and to the extent that any provision of this limited warranty should generally be found to be unenforceable, the unenforceable provision shall be severed from the warranty and deemed not to form part of the warranty. The remaining provisions of this warranty shall be and remain valid and enforceable. If and to the extent that any provision of this limited warranty as it relates to any of the Related Parties is found to be invalid or unenforceable in respect of that party (the "Excluded Party"), the Excluded Party shall be deemed to be severed or excluded from the provision, and the provision shall remain valid, enforceable and applicable in respect of the other or remaining Related Parties.

To the extent permitted by law, this limited warranty shall be governed and construed in accordance with the laws of Ontario.

If there is any inconsistency between this limited warranty, on the one hand, and any statement in the packaging of the Television or in any other document enclosed with, or used in the context of the promotion or sale of, the Television, on the other hand, the provisions of this limited warranty shall prevail.

How to Obtain Warranty Services

If, after following all of the operating instructions in this manual and checking the "Troubleshooting" section, you find that service is needed:

- (1) To find the nearest ASP, visit TCL's web site at www.toshiba.ca, or call toll free 1-800-268-3404
- (2) Present your bill of sale or other proof of purchase to the ASP.

For additional information, visit TCL's website at www.toshiba.ca

Chapter 9: Appendix

A copy of the GPL source code in this product may be obtained by contacting Toshiba Consumer Solutions at (800)631-3811. There will be a charge to cover the costs of providing the source code.

A copy of the LGPL source code in this product may be obtained by contacting Toshiba Consumer Solutions at (800)631-3811. There will be a charge to cover the costs of providing the source code.

USB Protocol Copyright © 2005 The NetBSD Foundation, Inc. All rights reserved.

Redistribution and use in source and binary forms, with or without modification, are permitted provided that the following conditions are met:

- (1) Redistributions of source code must retain the above copyright notice, this list of conditions and the following disclaimer.
- (2) Redistributions in binary form must reproduce the above copyright notice, this list of conditions and the following disclaimer in the documentation and/or other materials provided with the distribution.
- (3) Neither the name of The NetBSD Foundation nor the names of its contributors may be used to endorse or promote products derived from this software without specified prior written permission.

THIS SOFTWARE IS PROVIDED BY THE NETBSD FOUNDATION, INC. AND CONTRIBUTORS "AS IS" AND ANY EXPRESS OR IMPLIED WARRANTIES, INCLUDING, BUT NOT LIMITED TO, THE IMPLIED WARRANTIES OF MERCHANTABILITY AND FITNESS FOR A PARTICULAR PURPOSE ARE DISCLAIMED. IN NO EVENT SHALL THE FOUNDATION OR CONTRIBUTORS BE LIABLE FOR ANY DIRECT, INDIRECT, INCIDENTAL, SPECIAL, EXEMPLARY, OR CONSEQUENTIAL DAMAGES (INCLUDING, BUT NOT LIMITED TO, PROCUREMENT OF SUBSTITUTE GOODS OR SERVICES; LOSS OF USE, DATA, OR PROFITS; OR BUSINESS INTERRUPTION) HOWEVER CAUSED AND ON ANY THEORY OF LIABILITY, WHETHER IN CONTRACT, STRICT LIABILITY, OR TORT (INCLUDING NEGLIGENCE OR OTHERWISE) ARISING IN ANY WAY OUT OF THE USE OF THIS SOFTWARE, EVEN IF ADVISED OF THE POSSIBILITY OF SUCH DAMAGE.

This product includes software developed by the OpenSSL Project for use in the OpenSSL Toolkit (<http://www.openssl.org>).

This product includes cryptographic software written by Eric Young (ey@cryptsoft.com).

OpenSSL 0.9.7d Copyright © 1998-2000 the OpenSSL Project. All Rights reserved. Redistribution and use in source and binary forms, with or without modification, are permitted provided that the following conditions are met:

- (1) Redistributions of source code must retain the above copyright notice, this list of conditions and the following disclaimer.
- (2) Redistributions in binary form must reproduce the above copyright notice, this list of conditions and the following disclaimer in the documentation and/or other materials provided with the distribution.
- (3) All advertising materials mentioning features or use of this software must display the following acknowledgement: This product includes software developed by the OpenSSL Project for use in the OpenSSL Toolkit (<http://openssl.org>).
- (4) The names "OpenSSL Toolkit" and "Open SSL Project" must not be used to endorse or promote products derived from this software without prior written permission. For written permission, please contact openssl-core@openssl.org.
- (5) Products derived from this software may not be called "OpenSSL" nor may "Open SSL" appear in their names without prior written permission of the OpenSSL Project.
- (6) Redistributions of any form whatsoever must retain the following acknowledgement: "This product includes software developed by the OpenSSL Project for use in the OpenSSL Toolkit (<http://www.openssl.org>)."

THIS SOFTWARE IS PROVIDED BY THE OpenSSL PROJECT "AS IS" AND ANY EXPRESSED OR IMPLIED WARRANTIES, INCLUDING, BUT NOT LIMITED TO, THE IMPLIED WARRANTIES OF MERCHANTABILITY AND FITNESS FOR A PARTICULAR PURPOSE ARE DISCLAIMED. IN NO EVENT SHALL THE OpenSSL PROJECT OR CONTRIBUTORS BE LIABLE FOR ANY DIRECT, INDIRECT, INCIDENTAL, SPECIAL, EXEMPLARY, OR CONSEQUENTIAL DAMAGES (INCLUDING, BUT NOT LIMITED TO, PROCUREMENT OF SUBSTITUTE GOODS OR SERVICES; LOSS OF USE, DATA, OR PROFITS; OR BUSINESS INTERRUPTION) HOWEVER CAUSED AND ON ANY THEORY OF LIABILITY, WHETHER IN CONTRACT, STRICT LIABILITY, OR TORT (INCLUDING NEGLIGENCE OR OTHERWISE) ARISING IN ANY WAY OUT OF THE USE OF THIS SOFTWARE, EVEN IF ADVISED OF THE POSSIBILITY OF SUCH DAMAGE. This product includes cryptographic software written by Eric Young (ey@cryptsoft.com). This product includes software written by Tim Hudson (tjh@cryptsoft.com).

Copyright © 1995-1998 Eric Young (ey@cryptsoft.com). All Rights reserved. This package is an SSL implementation written by Eric Young (ey@cryptsoft.com). The implementation was written so as to conform with Netscapes SSL. This library is free for commercial and non-commercial use so long as the following conditions are adhered to. The following conditions apply to all code found in this distribution, be it the RC4, RSA, lhash, DES, etc., code; not just the SSL code. The SSL documentation included with this distribution is covered by the same copyright terms except that the holder is Tim Hudson (tjh@cryptsoft.com). Copyright remains Eric Young's, and as such any Copyright notices in the code are not to be removed. If this package is used in a product, Eric Young should be given attribution as the author of the parts of the library used. This can be in the form of a textual message at program startup or in documentation (online or textual) provided with the package.

Redistribution and use in source and binary forms, with or without modification, are permitted provided that the following conditions are met:

- (1) Redistributions of source code must retain the copyright notice, this list of conditions and the following disclaimer.
- (2) Redistributions in binary form must reproduce the above copyright notice, this list of conditions and the following disclaimer in the documentation and/or other materials provided with the distribution.
- (3) All advertising materials mentioning features or use of this software must display the following acknowledgement: "This product includes cryptographic software written by Eric Young (ey@cryptsoft.com). The word 'cryptographic' can be left out if the routines from the library being used are not cryptographic related."
- (4) If you include any Windows specific code (or derivative thereof) from the apps directory (application code) you must include an acknowledgement: "This product includes software written by Tim Hudson (tjh@cryptsoft.com)."

THIS SOFTWARE IS PROVIDED BY ERIC YOUNG "AS IS" AND ANY EXPRESS OR IMPLIED WARRANTIES, INCLUDING, BUT NOT LIMITED TO, THE IMPLIED WARRANTIES OF MERCHANTABILITY AND FITNESS FOR A PARTICULAR PURPOSE ARE DISCLAIMED. IN NO EVENT SHALL THE AUTHOR OR CONTRIBUTORS BE LIABLE FOR ANY DIRECT, INDIRECT, INCIDENTAL, SPECIAL, EXEMPLARY, OR CONSEQUENTIAL DAMAGES (INCLUDING, BUT NOT LIMITED TO, PROCUREMENT OF SUBSTITUTE GOODS OR SERVICES; LOSS OF USE, DATA, OR PROFITS; OR BUSINESS INTERRUPTION) HOWEVER CAUSED AND ON ANY THEORY OF LIABILITY, WHETHER IN CONTRACT, STRICT LIABILITY, OR TORT (INCLUDING NEGLIGENCE OR OTHERWISE) ARISING IN ANY WAY OUT OF THE USE OF THIS SOFTWARE, EVEN IF ADVISED OF THE POSSIBILITY OF SUCH DAMAGE. The license and distribution terms for any publicly available version or derivative of this code cannot be changed, i.e. this code cannot simply be copied and put under another distribution license (including the GNU Public License).

Index

A

Antenna cable 13
 Antenna input configuration 31
 Audio quality adjustments 47
 Audio system connection 20
 Auto aspect 43
 Auto power off 55

B

Back of the TV 12
 Base closed captions 45
 Blocking channels 51

C

Cable box connection 15
 CableClear® 58
 Camcorder connection 18
 CH ▲▼ buttons 23, 40
 CH RTN button 23, 40
 Channel Browser Setup 38
 Channel Browser™ 38
 Channel labeling 33
 Channel Number buttons 23, 40
 Channel programming
 Automatic programming 32
 Manually adding and deleting... 32
 Cinema mode 43
 Closed captions 45
 Color temperature 57
 ColorStream® 16
 Component video 16
 Component video cables 13
 Connecting cables 13

D

Digital Audio Out 20
 Digital audio selector 46
 Digital CC Settings 45
 Digital signal meter 35
 Dolby Digital 20
 Dolby Digital Dynamic Range
 Control 48
 DVD player connection 16
 DVI connection 19
 Dynamic contrast 56

F

Features, TV 9
 Front of the TV 11

G

Game Mode feature 59

H

HDMI audio mode 34
 HDMI cable 13
 HDMI™ connection 19

I

INFO button 55
 INPUT button 37
 Installation, care, and service 3
 Installation, setup 10
 Integrated digital tuning 9
 IR blaster 17
 IR OUT connection 17

L

Labeling video input 37
 Lamp mode 57
 Lamp unit replacement 63
 Language selection 31
 Last mode memory feature 55
 LED indications 11, 62
 LOCKS menu
 Channels, blocking 51
 Enable rating blocking 50
 New PIN code 49
 Panel lock 53
 Unlocking programs
 temporarily 52
 Video inputs, locking 52
 Locks menu 49

M

MPEG noise reduction 58
 MTS feature 47
 MUTE button 46

O

Optical audio cable 13
 Optical audio output format 48

P

PC Audio 54
 PC connection 21
 PC settings 53
 Picture adjustment 44
 Picture mode 44
 Picture quality 44
 Picture scroll 42
 Picture size selection 41
 POWER button 11, 23
 Power-On Mode 35

R

RECALL button 55
 Remote control
 Battery installation 22
 Device code table 27
 Effective range 22
 Functional key chart 25
 Learning about the buttons 23
 Programming 26
 Reset Factory Defaults 36

S

Safety 2
 SAP sound 47
 Satellite receiver connection 16
 Scroll settings 42
 Selecting Menu Language 31
 Service 4
 Side panel control 11
 Sleep timer 54
 Specifications 66
 StableSound® 48
 Stereo sound 47
 SurfLock™ 40
 S-video cable 13
 System status 36

T

TheaterWide® picture size 41
 Troubleshooting 60
 TV status information 55

V

V-Chip blocking (Locks menu) 49
 VCR connection 14, 15, 16
 Video cables 13
 Video input label 37
 Video input lock 52

W

Warranty
 Canada 68
 U.S. 67
 WOW:SRS 3D 59
 WOW:SRS Focus 59
 WOW:SRS TruBass 59

Notes

Notes

TOSHIBA AMERICA CONSUMER PRODUCTS, L.L.C.

Corporate Headquarters: 82 TOTOWA ROAD, WAYNE, NJ 07470, U.S.A.
NATIONAL SERVICE DIVISION: 1420-B TOSHIBA DRIVE, LEBANON, TN 37087, U.S.A.

TOSHIBA OF CANADA LTD.

HEAD OFFICE: 191 McNABB STREET, MARKHAM, ONTARIO, L3R 8H2, CANADA – TEL: (905) 470-5400
SERVICE CENTERS:
TORONTO: 191 McNABB STREET, MARKHAM, ONTARIO L3R 8H2, CANADA – TEL: (905) 470-5400
MONTREAL: 18050 TRANS CANADA, KIRKLAND, QUEBEC, H9J 4A1, CANADA – TEL: (514) 390-7766
VANCOUVER: 13551 COMMERCE PARKWAY, SUITE 110, RICHMOND, B.C., V6V 2L1, CANADA – TEL: (604) 303-2500

MANUFACTURED BY
TOSHIBA AMERICA CONSUMER PRODUCTS, L.L.C.

CableClear, ColorStream, StableSound, and TheaterWide are registered trademarks of Toshiba America Consumer Products, L.L.C.
Channel Browser and SurfLock are trademarks of Toshiba America Consumer Products, L.L.C.
DLP® and the DLP logo are registered trademarks of Texas Instruments.

PRINTED IN USA
(07-04)

TOSHIBA